

Prestomatic Push-In Fittings

Prestomatic 3 Fittings

Elbows

C68UNPMK
Page 1-85



V68UNPMK
Page 1-85



Tees

R68UNPMK
Page 1-85



JNPMK
Page 1-85



Prestomatic 2 Stud Fittings

Straights

F8UNPMB
Page 1-87



F2NPMB
Page 1-87



WEONPMB
Page 1-87



Elbows

C8UNPMB
Page 1-88



V8UNPMB
Page 1-88



Tees

S8UNPMB
Page 1-88



S8UNPMBPPAM
Page 1-88



Prestomatic 2 Tube-to-Tube Fittings

Straights

HNPMB
Page 1-89



WNPMB
Page 1-89



Elbow

T2ENPMB
Plug-In
Page 1-89



Tee

JNPMB
Page 1-89



Adaptors and Accessories for Braking Systems

Elbows

D8C8UB
Page 1-90



D8V8UB
Page 1-90



Tees

MR08UB
Page 1-90



MMS8UB
Page 1-90



MM08BKT
Page 1-90



Increases

F8UG8B
Page 1-91



Reducers

F8UG8B
Page 1-91



Conversion Fittings

F8UGB
Metric Male / NPT Female
Page 1-91



F8UG4B
Metric Male / BSPP Female
Page 1-91



Straight Connectors

F8UHA8UB
Page 1-91



Bulkhead Connector Fittings

WGG88B
Page 1-92



WG8F8UB
Page 1-92



Test Points

PPRF8UM
Page 1-92



PPRC8UM
Page 1-92



PPRV8UM
Page 1-92



Plugs and Accessories

P8UNBL
Page 1-93



3126
Page 1-93



VDPF8UM
Drain valve
Page 1-93



WLNB
Page 1-93



Prestomatic 3 Push-In Fittings

In order to meet **severe** and **demanding** conditions of use in air circuits in rail and road transportation, this range of **lightweight** polyamide fittings offers **excellent technical performance** and respects the new environmental requirements.

Product Advantages

Optimum Design

- Extreme compactness for space-saving
- Weight reduction over traditional airbrake fittings
- Integrated polymer tube support gives tube alignment and tube retention for:
 - excellent resistance to vibration
 - sealing ensured over time
- Fully re-usable; reduces maintenance costs

High Performance

- Positive hold by an innovative gripping ring design allowing absorption of vibration and pulsating pressure
- Excellent mechanical properties adapted to demanding working conditions
- UV-resistant polymer guarantees a long lifespan
- Twist-free assembly allowing free tube rotation even under pressure and high resistance to tube expansion
- Extreme temperature resistance for increased lifespan

Reliability

- 100% leak-tested in production
- Date coding to guarantee quality and traceability
- Suitable with flexible tubing in braking system



Air Braking Systems
Air Suspension
Chassis
Engine Braking
Gearbox
Pantograph
Motricity Control

Applications

Technical Characteristics

Compatible Fluids	Compressed air
Working Pressure	25 bar
Working Temperature	-40°C to +100°C For lower temperature applications, please consult us

Tightening Torques (daN.m)	Threads				
	M10x1	M12x1.5	M14x1.5	M16x1.5	M22x1.5
	8 to 10	10 to 20	15 to 20	15 to 20	20 to 30

Male metric threads conform to DIN 3852-1, DIN 3852-3, ISO 4039-2 and ISO 6149-1 standards.

Component Materials

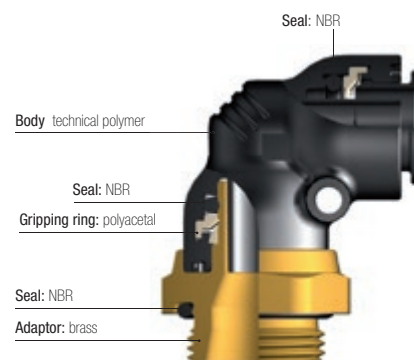

Silicone-free

Regulations

Fully adapted to transportation braking system applications with tubing conformed to:
DIN 74324-1
DIN 73378
NF-R12-632-2

Prestomatic 3 Push-In Fittings

C68UNPMK 90° Elbow, Male Metric Thread

Technical polymer, brass, NBR

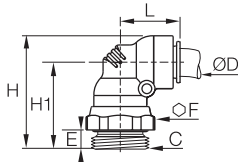

ØD	C		E	F	H	H1	L	Kg
8	M12x1.5	C68UNPMK8M12	7.5	17	40	31	20.5	0.024
	M14x1.5	C68UNPMK8M14	7.5	19	40	31	20.5	0.027
	M16x1.5	C68UNPMK8M16	8	22	41	32	20.5	0.034
	M22x1.5	C68UNPMK8M22	8	27	41	32	20.5	0.046
10	M12x1.5	C68UNPMK10M12	7.5	17	47	36	25	0.031
	M16x1.5	C68UNPMK10M16	8	22	47	37	25	0.043
12	M22x1.5	C68UNPMK10M22	8	27	48	38	25	0.062
	M12x1.5	C68UNPMK12M12	7.5	17	49	37.5	26	0.035
	M16x1.5	C68UNPMK12M16	8	22	50	38.5	26	0.047
16	M22x1.5	C68UNPMK12M22	8	27	50	37.5	26	0.058
	M16x1.5	C68UNPMK16M16	8	22	53	39.5	27	0.059
	M22x1.5	C68UNPMK16M22	8	27	53	39.5	27	0.070

The body swivels for positioning purposes.

V68UNPMK 45° Elbow, Male Metric Thread

Technical polymer, brass, NBR

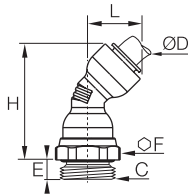

ØD	C		E	F	H	L	Kg
10	M22x1.5	V68UNPMK10M22	8	27	61	23	0.060
12	M16x1.5	V68UNPMK12M16	8	22	63	24.5	0.045
	M22x1.5	V68UNPMK12M22	8	27	62	24.5	0.057
16	M22x1.5	V68UNPMK16M22	8	27	66	27	0.071

The body swivels for positioning purposes.

R68UNPMK Stud Run Tee, Male Metric Thread

Technical polymer, brass, NBR

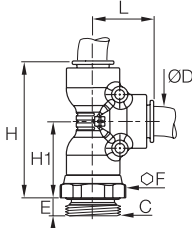

ØD	C		E	F	H	H1	L	Kg
8	M12x1.5	R68UNPMK8M12	7.5	17	51	31	20.5	0.028
12	M16x1.5	R68UNPMK12M16	8	22	64.5	38.5	26	0.053
16	M16x1.5	R68UNPMK16M16	8	22	68	39.5	27	0.067

The body swivels for positioning purposes.

JNPMK Equal Tee

Technical polymer, NBR

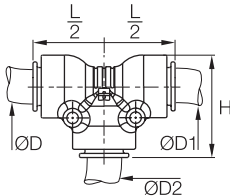

ØD	ØD1	ØD2		H	L/2	Kg
8	8	8	JNPMK8	30	20.5	0.012
10	10	10	JNPMK10	35.5	25	0.019
12	12	12	JNPMK12	37.5	26	0.022
16	16	16	JNPMK16	41	27	0.028

Other Configurations Available on Request



F Male Elbow



90° Male Side Tee



Male Branch Tee



Male Branch Tee In-Line Test Point



ISO 8434-1 Bulkhead Tee

Prestomatic 2 Push-In Fittings

To meet **severe** and **demanding applications** such as pneumatic circuits in rail and road transportation, Prestomatic 2 fittings conform to the international standards offering **robustness, reliability** and **mechanical resistance**.

Product Advantages

Versatility | Extreme compactness for space-saving
 High robustness
 Excellent mechanical properties adapted to severe working conditions
 Integrated metallic tube support reinforces tube alignment and tube retention for:

- excellent resistance to vibration
- sealing ensured over time
- increased resistance to tube removal

Fully re-usable to reduce maintenance costs

High Performance | Positive hold by an innovative gripping ring design allowing absorption of vibration and pulsating pressure
 Twist-free assembly allowing free tube rotation even under pressure and high resistance to tube expansion
 Extreme temperature resistance: up to -50°C for increased lifespan

Reliability | 100% leak-tested in production
 Date coding to guarantee quality and traceability
 Suitable with flexible tubing in braking system



Applications

- Air Braking Systems
- Air Suspension
- Chassis
- Engine Braking
- Gearbox
- Pantograph
- Motricity Control

Technical Characteristics

Compatible Fluids	Compressed air
Working Pressure	25 bar
Working Temperature	-40°C to +100°C For lower temperature applications, please consult us

Tightening Torques (daN.m)	Threads				
	M10x1	M12x1.5	M14x1.5	M16x1.5	M22x1.5
	8 to 10	10 to 20	15 to 20	15 to 20	20 to 30

Male metric threads conform to DIN 3852-1, DIN 3852-3, ISO 4039-2 and ISO 6149-1 standards.

Component Materials

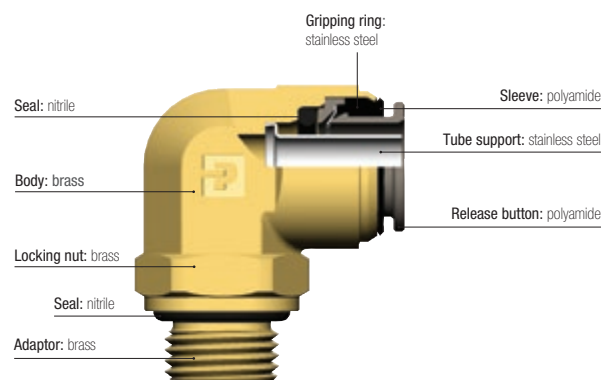

Silicone-free

Regulations

EN 45545-2: HL3, R22, R24, R25 classification can be attained when used with fireproof tubing

Fully adapted to transportation braking system applications with tubing:
 DIN 74324-1
 DIN 73378
 NF-R12-632-2

Stud Fittings

F8UNPMB

Stud Fitting, Male Metric Thread

Brass, NBR

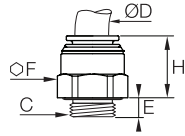

ØD	C		E	F	H	Kg
6	M10x1	F8UNPMB6M10	7	16	18.5	0.018
	M12x1.5	F8UNPMB6M12	7.5	17	16	0.017
	M16x1.5	F8UNPMB6M16	8	22	14.5	0.032
8	M22x1.5	F8UNPMB6M22	8	27	13.5	0.053
	M12x1.5	F8UNPMB8M12	7.5	17	19.5	0.021
	M14x1.5	F8UNPMB8M14	7.5	19	18	0.025
10	M16x1.5	F8UNPMB8M16	8	22	15	0.030
	M22x1.5	F8UNPMB8M22	8	27	13.5	0.052
	M12x1.5	F8UNPMB10M12	7.5	22	22.5	0.036
12	M14x1.5	F8UNPMB10M14	7.5	22	22	0.036
	M16x1.5	F8UNPMB10M16	8	22	20.5	0.038
	M22x1.5	F8UNPMB10M22	8	27	14.5	0.049
16	M12x1.5	F8UNPMB12M12	7.5	22	22.5	0.035
	M16x1.5	F8UNPMB12M16	8	22	21	0.033
	M22x1.5	F8UNPMB12M22	8	27	17.5	0.052
16	M16x1.5	F8UNPMB16M16	8	27	22.5	0.063
	M22x1.5	F8UNPMB16M22	8	27	22.5	0.069

F2NPMB

Stud Fitting, Male NPT thread

Brass, NBR

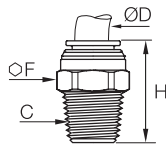

ØD	C		F	H	Kg
6	NPT1/8	F2NPMB6-1/8	16	25	0.015
	NPT1/4	F2NPMB6-1/4	16	25	0.020
	NPT3/8	F2NPMB6-3/8	19	27	0.037
8	NPT1/4	F2NPMB8-1/4	17	30	0.025
	NPT3/8	F2NPMB8-3/8	19	27	0.033
10	NPT1/4	F2NPMB10-1/4	22	35.5	0.044
	NPT1/2	F2NPMB10-1/2	22	34	0.066
12	NPT3/8	F2NPMB12-3/8	22	31	0.038
	NPT1/2	F2NPMB12-1/2	22	34	0.058

WEONPMB

Equal Mixed Bulkhead Adapter

Brass, NBR

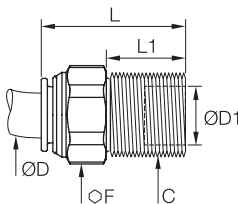

ØD	ØD1	C		F	L	L1	Kg
8	M14x1.5	WEONPMB8-8L		19	36	21	0.033
8	10	M16x1.5	WEONPMB8-10L	19	36	21	0.038
	12	M18x1.5	WEONPMB8-12L	22	34	21	0.046
12	12	M18x1.5	WEONPMB12-12L	22	37	21	0.046

Other Configurations Available on Request



Male Bulkhead



Male Run Tee



F Male Elbow



ISO 8434-1 Bulkhead Elbow



Male Run Tee Branch Test Point

Stud Fittings

C8UNPMB

90° Elbow, Male Metric Thread

Brass, NBR

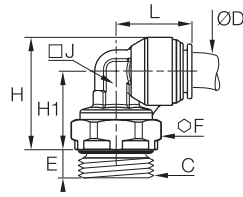

ØD	C		E	F	H	H1	J	L	Kg
6	M10x1	C8UNPMB6M10	7.5	14	24	16	10	22	0.032
	M12x1.5	C8UNPMB6M12	9	17	25.5	17	11	22	0.038
	M16x1.5	C8UNPMB6M16	9.5	22	30	20	13	23	0.062
8	M22x1.5	C8UNPMB6M22	9.5	27	35	24	14	23	0.095
	M12x1.5	C8UNPMB8M12	9	17	25.5	17	11	22	0.039
	M14x1.5	C8UNPMB8M14	9.5	19	26.5	18	11	22	0.046
10	M16x1.5	C8UNPMB8M16	9.5	22	30	20	13	23	0.061
	M22x1.5	C8UNPMB8M22	9.5	27	35	24	14	23	0.092
	M16x1.5	C8UNPMB10M16	9.5	22	30.5	20.5	13	25	0.063
12	M22x1.5	C8UNPMB10M22	9.5	27	37	26	14	25	0.099
	M12x1.5	C8UNPMB12M12	9	17	32	21	14	25	0.063
	M16x1.5	C8UNPMB12M16	9.5	22	33	22	14	25	0.072
16	M22x1.5	C8UNPMB12M22	9.5	27	37	26	14	25	0.095
	M16x1.5	C8UNPMB16M16	9.5	22	37	23.5	24	34	0.170
	M22x1.5	C8UNPMB16M22	9.5	27	39	25.5	24	34	0.174

The body can be locked in the desired orientation with the locknut.

V8UNPMB

45° Elbow, Male Metric Thread

Brass, NBR

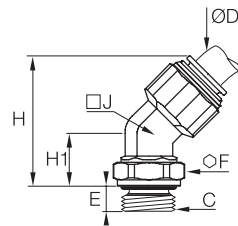

ØD	C		E	F	H	H1	J	Kg
8	M16x1.5	V8UNPMB8M16	9.5	22	38	17.5	14	0.063
10	M22x1.5	V8UNPMB10M22	9.5	27	44	21	14	0.085
12	M16x1.5	V8UNPMB12M16	9.5	22	44	17.5	14	0.074
	M22x1.5	V8UNPMB12M22	9.5	27	48	21	14	0.095
16	M22x1.5	V8UNPMB16M22	9.5	27	42	18	22	0.106

The body can be locked in the desired orientation with the locknut.

S8UNPMB

Stud Branch Tee, Male Metric Thread

Brass, NBR

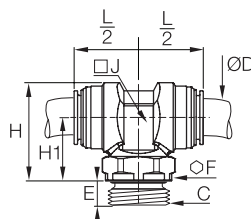

ØD	C		E	F	H	H1	J	L/2	Kg
8	M16x1.5	S8UNPMB8M16	9.5	22	39	27	14	24	0.097
	M22x1.5	S8UNPMB8M22	9.5	27	42	30.5	14	24	0.118
10	M16x1.5	S8UNPMB10M16	9.5	22	39	27	14	25.5	0.100
	M22x1.5	S8UNPMB10M22	9.5	27	42	30.5	14	25.5	0.118
12	M16x1.5	S8UNPMB12M16	9.5	22	39	27	14	27	0.110
	M22x1.5	S8UNPMB12M22	9.5	27	42	30.5	14	27	0.131
16	M22x1.5	S8UNPMB16M22	9.5	27	40	26	19	27	0.171

The body can be locked in the desired orientation with the locknut.

S8UNPMBPPAM

Stud Branch Tee, Male Metric Thread, In-Line Test Point

Brass, NBR

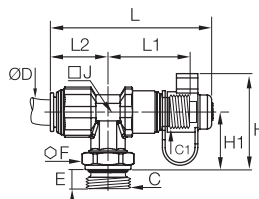

ØD	C	C1		E	F	H	H1	J	L	L1	L2	Kg
10	M16x1.5	M16x1.5	S8UNPMB10PPAM16	9.5	22	45	27	14	71	36	25	0.125
12	M16x1.5	M16x1.5	S8UNPMB12PPAM16	9.5	22	45	27	14	75	38	27	0.133
	M22x1.5	M16x1.5	S8UNPMB12PPAM22	9.5	27	48.5	30.5	14	75	38	27	0.154

The body can be locked in the desired orientation with the locknut.

Tube-to-Tube Fittings

HNPMB

Equal Connector

Brass, NBR

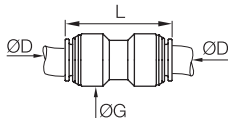

ØD		G	L	Kg
6	HNPMB6	16	37.5	0.024
8	HNPMB8	18	37	0.029
10	HNPMB10	20	41	0.036
12	HNPMB12	22	41	0.041
16	HNPMB16	27	41	0.078

WNPMB

Equal Bulkhead Connector

Brass, NBR

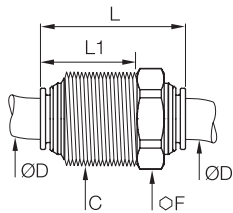

ØD	C		F	L	L1	Kg
6	M18x1.5	WNPMB6	22	39.5	26	0.056
8	M20x1.5	WNPMB8	22	39	26	0.061
10	M22x1.5	WNPMB10	24	43	28	0.076
12	M24x1.5	WNPMB12	27	44	29	0.091

T2ENPMB

Equal and Unequal 90° Plug-In Elbow

Brass, NBR

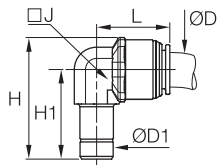

ØD	ØD1		H	H1	J	L	Kg
6	8	T2ENPMB6	36	27.5	10	21	0.025
8	8	T2ENPMB8	36	27.5	10	22	0.025
10	12	T2ENPMB10	44	32.5	14	25.5	0.049
12	12	T2ENPMB12	44	32.5	14	27	0.051

JNPMB

Equal and Unequal Tee

Brass, NBR

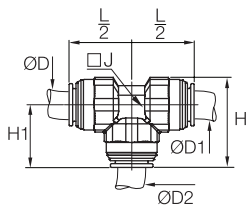

ØD	ØD1	ØD2		H	H1	J	L/2	Kg
6	6	6	JNPMB6	30	22	12	22	0.044
8	8	8	JNPMB8	31	23	12	23	0.050
		12	JNPMB8-8-12	37	25	14	23	0.077
10	10	10	JNPMB10	37	25.5	14	25.5	0.086
		6	JNPMB10-10-6	36	24	14	23	0.073
		10	JNPMB10-6-10	37	25.5	14	25.5	0.083
12	12	12	JNPMB12	38	26.5	14	26.5	0.093
		6	JNPMB12-12-6	35	24	14	26	0.086
		8	JNPMB12-12-8	35	24	14	26	0.085
16	16	16	JNPMB16	46	29	30	29	0.189

Air Brake Adaptors

D8C8UB

90° Elbow, Male/Female Metric Thread

Brass, NBR

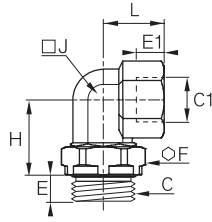

C	C1		E	E1	F	H	J	L	Kg
M16x1.5	M16x1.5	M16M16D8C8UB	9.5	10	22	23.5	16	18.5	0.081
	M16x1.5	M16M22D8C8UB	10.5	10	27	26.5	19	21.5	0.132
	M22x1.5	M22D8C8UB	10.5	12	27	29.5	19	23.5	0.134

The body can be locked in the desired orientation with the locknut.

D8V8UB

45° Elbow, Male/Female Metric Thread

Brass, NBR

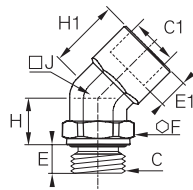

C	C1		E	E1	F	H	H1	J	Kg
M16x1.5	M16x1.5	M16M16D8V8UB	9.5	10	22	15.5	22	17	0.077

The body can be locked in the desired orientation with the locknut.

MR08UB

Female Run Tee, Male Metric Thread

Laiton, NBR

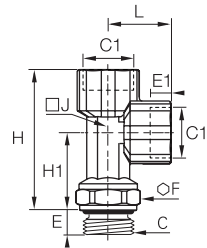

C	C1		E	E1	F	H	H1	J	L	Kg
M12x1.5	M12x1.5	M12MR08UB	9	10	17	50.5	30	14	20.5	0.117
M16x1.5	M16x1.5	M16MR08UB	10	10	22	62.5	39	14	23.5	0.134
	M16x1.5	M16M22M16MR08UB	10.5	10	27	65	41.5	14	23.5	0.178
	M22x1.5	M22MR08UB	10.5	12	27	69.5	41.5	18	28	0.222

The body can be locked in the desired orientation with the locknut.

MMS8UB

Branch Tee, Male/Female Metric Thread

Brass, NBR

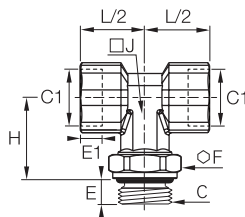

C	C1		E	E1	F	H	J	L/2	Kg
M12x1.5	M12x1.5	M12MMS8UB	9	10	17	25.5	14	23.5	0.140
M16x1.5	M16x1.5	M16MMS8UB	10	10	22	29	14	23.5	0.134
M22x1.5	M16x1.5	M16M16M22MMS8UB	10.5	10	27	31	14	23.5	0.175

The body can be locked in the desired orientation with the locknut.

MM08BKT

Tee with Mounting Boss, Female Metric Thread

Brass, NBR

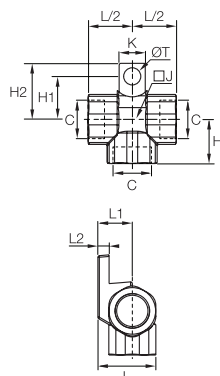

C		H	H1	H2	J	K	L	L1	L2	L/2	ØT	Kg
M16x1.5	M16MM08BKT	20.5	26	20	19	12	27	16	5	20.5	8	0.112

Air Brake Adaptors and Accessories

F8UG8B

Increaser, Male/Female Metric Thread

Brass, NBR

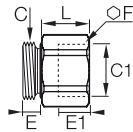

C	C1		E	E1	F	L	Kg
M12x1.5	M16x1.5	M12M16F8UG8B	7.5	10	22	17.5	0.044

F8UG8B

Reducer, Male/Female Metric Thread

Brass, NBR

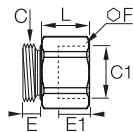

C	C1		E	E1	F	L	Kg
M16x1.5	M12x1.5	M16M12F8UG8B	8	10	22	15	0.051
M22x1.5	M16x1.5	M22M16F8UG8B	8	10	27	16	0.073

F8UGB

Conversion Fitting, Male Metric/Female NPT Thread

Brass, NBR

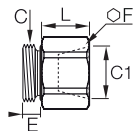

C	C1		E	F	L	Kg
M16x1.5	NPT1/4	M16-1/4F8UGB	8	22	15	0.050
M22x1.5	NPT3/8	M22-3/8F8UGB	8	27	18	0.080

F8UG4B

Conversion Fitting, Male Metric/Female BSPP Thread

Brass, NBR

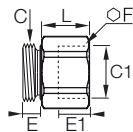

C	C1		E	E1	F	L	Kg
M16x1.5	G1/4	M16-1/4F8UG4B	8	10	22	11.5	0.038
	G1/8	M16-1/8F8UG4B	8	7	22	8	0.031

F8UHA8UB

Straight Male Adaptor, Male Metric Thread

Brass, NBR

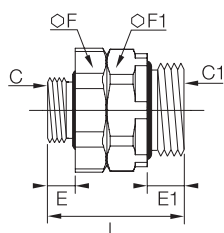

C	C1		E	E1	F	F1	L	Kg
M16x1.5	M16x1.5	M16F8UHA8UB	8	10	22	22	32	0.056
	M22x1.5	M16M22F8UHA8UB	8	10.5	27	27	36	0.096
M22x1.5	M22x1.5	M22F8UHA8UB	8	10.5	27	27	36	0.096

Air Brake Adaptors and Accessories

WGG88B

Bulkhead Union, Female Metric Thread

Brass, NBR

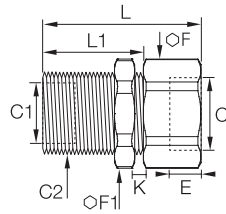

C	C1	C2		E	F	F1	K _{max}	L	L1	Kg
M16x1.5	M16x1.5	M22x1.5	M16WGG88BH27	10	27	27	16	30	23	0.082
M22x1.5	M16x1.5	M26x1.5	M22M16WGG88B	12	30	32	10	32	18	0.128

WG8F8UB

Bulkhead Union, Male/Female Metric Thread

Brass, NBR

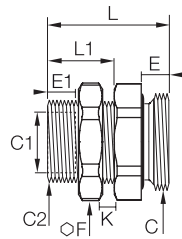

C	C1	C2		E	E1	F	K _{max}	L	L1	Kg
M16x1.5	M16x1.5	M22x1.5	M16WG8F8UB	8	10	27	10	32	17	0.086
M22x1.5	M16x1.5	M22x1.5	M16M22WG8F8UB	8	10	27	10	32	17	0.080

PPRF8UM

Stud Test Point, Male Metric Thread

Brass, NBR

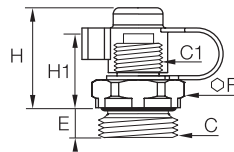

C	C1		E	F	H	H1	Kg
M16x1.5	M16x1.5	PPRF8UM16	9.5	22	34.5	31.5	0.057
M22x1.5	M16x1.5	PPRF8UM22	9.5	27	34.5	31.5	0.072

PPRC8UM

Test Point 90° Elbow, Male Metric Thread

Brass, NBR

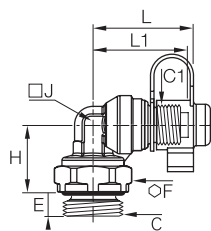

C	C1		E	F	H	J	L	L1	kg
M22x1.5	M16x1.5	PPRC8UM22	10.5	27	18	19	39	36	0.142

The body can be locked in the desired orientation with the locknut.

PPRV8UM

Test Point 45° Elbow, Male Metric Thread

Brass, NBR

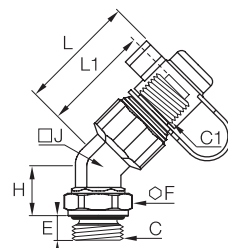

C	C1		E	F	H	J	L	L1	kg
M22x1.5	M16x1.5	PPRV8UM22	10.5	27	32	14	38	35	0.119

The body can be locked in the desired orientation with the locknut.

Air Brake Adaptors and Accessories

VDPF8UM

Drain Valve, Male Metric Thread

Brass, NBR

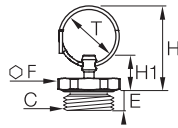

C		E	F	H	H1	ØT	Kg
M22x1.5	VDPF8UM22L13	7.5	27	47.5	24	26	0.037

P8UNBL

Plug, Male Metric Thread

Brass, NBR

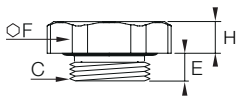

C		E	F	H	Kg
M12x1.5	M12P8UNBL	7.5	17	4.5	0.013
M14x1.5	M14P8UNBL	7.5	17	4.5	0.016
M16x1.5	M16P8UNBL	8	22	5	0.022
M22x1.5	M22P8UNBL13	7.5	27	5	0.038

3126

Blanking Plug

Technical polymer

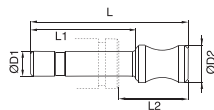

ØD		G	L	L1	Kg
6	3126 06 00	8	33	16,5	0,001
8	3126 08 00	10	35	17,5	0,001
10	3126 10 00	12	42	21	0,002
12	3126 12 00	14	45	22	0,003

WLNB

Bulkhead Locknut

Brass

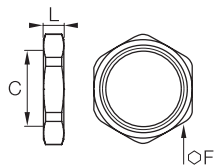

C		F	L	Kg
M16x1.5	WL8NBM16X1.5	22	5	0.010
M18x1.5	WL8NBM18X1.5	22	5	0.008
M20x1.5	WL8NBM20X1.5	24	5	0.008
M22x1.5	WL8NBM22X1.5	27	6	0.014
M24x1.5	WL8NBM24X1.5	30	7	0.019

