

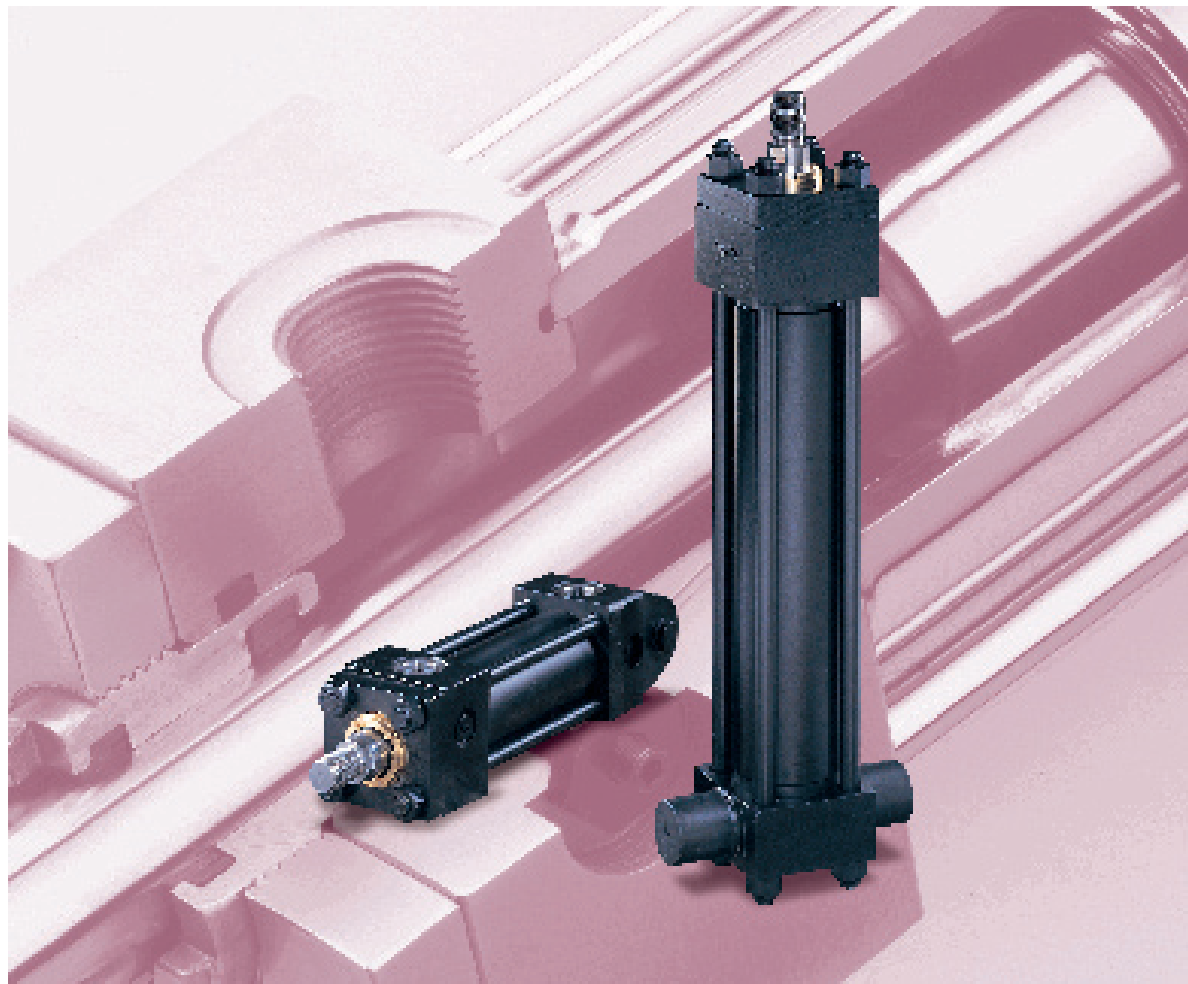

# **2H Tie Rod Cylinders**

*Heavy Duty NFPA Hydraulic Cylinders  
for working pressures up to 210 bar*

*Catalogue HY07-1110/UK*



**2H Cylinder Mounting Styles**

The standard range of Parker 2H cylinders comprises 17 mounting styles. Dimensional information for each mounting style is shown on pages 10-21 for 38.1mm to 203.2mm (1½" to 8") bore sizes, and on pages 22-25 for 254mm and 304.8mm (10" and 12") bore sizes.

Application-specific mounting information is shown on pages 30-31.

Where a non-standard mounting style is required, please contact the factory for details.

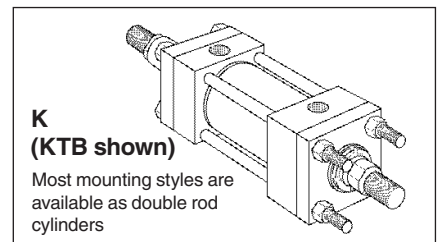
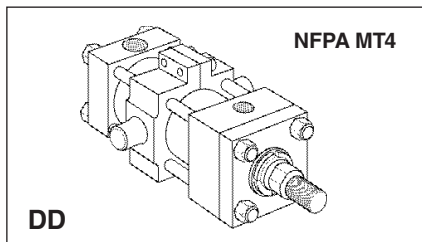
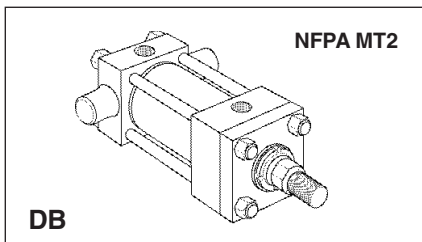
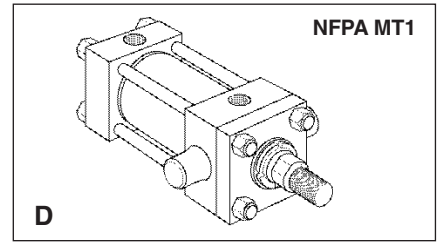
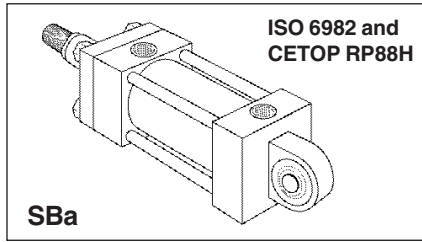
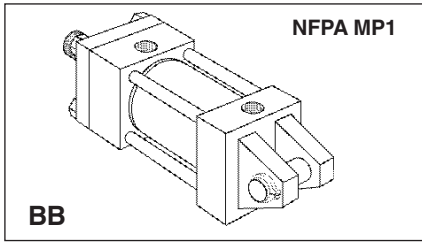
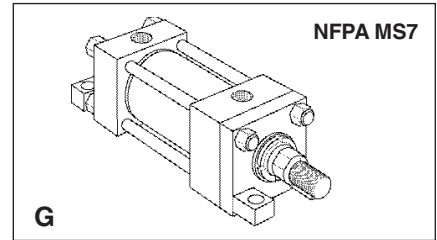
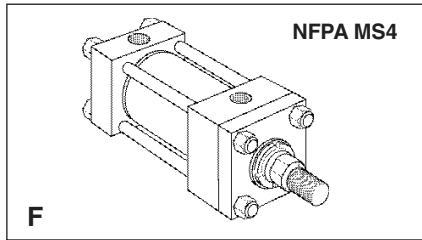
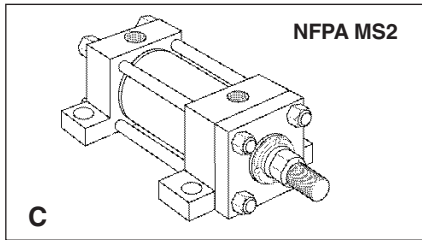
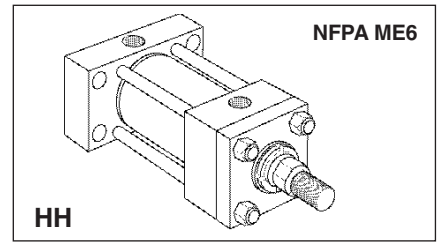
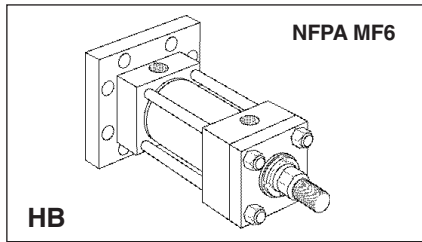
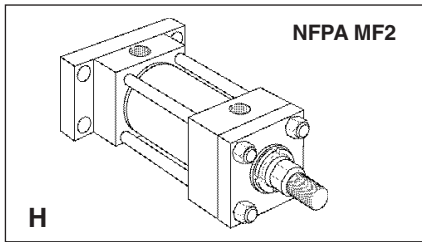
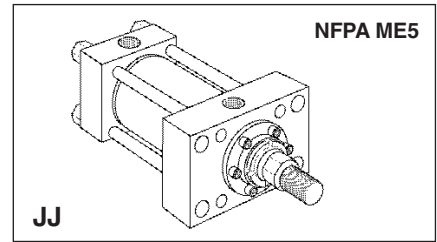
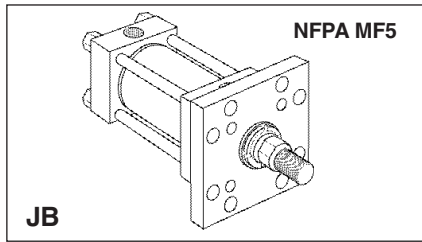
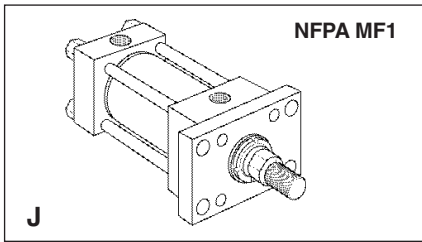
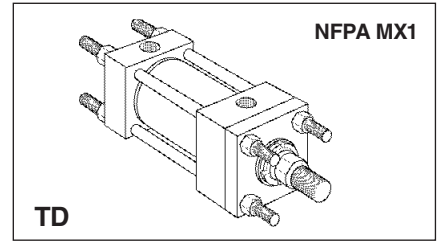
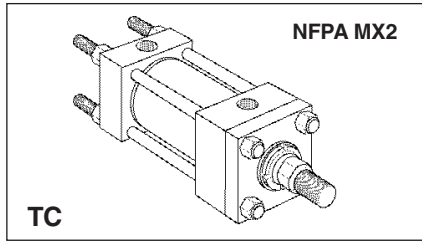
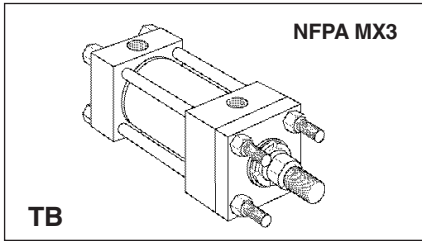

**38.1mm to 203.2mm (1½" to 8") Bores Only**

**Rod End Styles 4, 7 & 8**  
**– All Except JJ Mount**

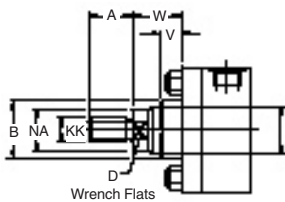

**Rod End Style 9**  
**– All Except JJ Mount**

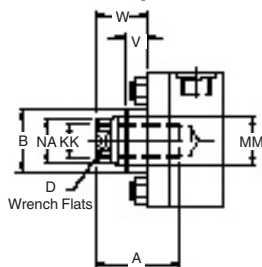

**Rod End Styles 4, 7 & 8**  
**– JJ Mount Only**

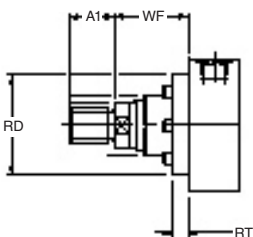

**Rod End Style 9**  
**– JJ Mount Only**

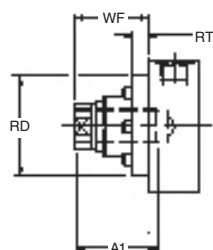

**Rod End Styles 4 & 8**

The standard rod end, Style 4, is recommended for all applications in which the work piece is secured against the rod shoulder. Where the work piece is not shouldered, Style 8 rod ends are recommended.

**Rod End Style 9**

For applications where a female thread is required.

**Rod End Style 3**

Non-standard piston rod ends are designated 'Style 3'. A dimensional sketch or description should accompany the order. Please specify dimensions KK and A.

**Rod End Style 7**

Style 7 rod ends apply to rod eyes with spherical bearings only (see pages 27 and 29). The Style 7 rod end with spherical bearing allows the same diameter pivot pin to be used at both the head and cap ends of the cylinder. For Style 7 rod end thread lengths, please refer to dimension A1 in the table below.

**Style JJ**

Dimensions which are not shown are identical to those shown for the equivalent non-JJ design.

**Rod End Dimensions – 38.1mm to 203.2mm (1½" to 8") bore sizes only**

Bore Ø	Rod No.	MM Rod Diameter	Style 4 & 9		Style 8		Style 7 <sup>2</sup>		A	B <sup>+0.00</sup> <sub>-0.05</sub>	D	NA	V	W	JJ Mount Only		
			KK Metric	KK UNF <sup>1</sup>	KK Metric	KK UNF	KK Metric	A1							RD max.	RT	WF
38.1 (1½")	1	15.9 (5/8")	M10x1.5	7/16 - 20	M12x1.5	1/2 - 20	–	21	19.0	28.55	13	14.3	6.4	15.9	54.0	9.5	25.4
	2	25.4 (1")	M20x1.5	3/4 - 16	M22x1.5	7/8 - 14	M16x1.5	–	28.6	38.07	22	23.8	12.7	25.4	63.5	9.5	35.0
50.8 (2")	1	25.4 (1")	M20x1.5	3/4 - 16	M22x1.5	7/8 - 14	M20x1.5	27	28.6	38.07	22	23.8	6.4	19.1	63.5	9.5	35.0
	2	34.9 (1 3/8")	M26x1.5	1 - 14	M30x2	1 1/4 - 12	M20x1.5	–	41.3	50.77	30	33.3	9.5	25.4	76.2	9.5	41.3
63.5 (2 1/2")	1	25.4 (1")	M20x1.5	3/4 - 16	M22x1.5	7/8 - 14	–	35	28.6	38.07	22	23.8	6.4	19.1	63.5	9.5	35.0
	2	44.5 (1 3/4")	M33x2	1 1/4 - 12	M39x2	1 1/2 - 12	M27x2	–	50.8	60.30	36	42.9	12.7	31.8	88.9	9.5	47.7
	3	34.9 (1 3/8")	M26x1.5	1 - 14	M30x2	1 1/4 - 12	M27x2	–	41.3	50.77	30	33.3	9.5	25.4	76.2	9.5	41.3
82.6 (3 1/4")	1	34.9 (1 3/8")	M26x1.5	1 - 14	M30x2	1 1/4 - 12	–	44	41.3	50.77	30	33.3	6.4	22.2	76.2	9.5	41.3
	2	50.8 (2")	M39x2	1 1/2 - 12	M45x2	1 3/4 - 12	M33x2	–	57.1	66.65	41	49.2	9.5	31.8	101.6	15.9	50.8
	3	44.5 (1 3/4")	M33x2	1 1/4 - 12	M39x2	1 1/2 - 12	M33x2	–	50.8	60.30	36	42.9	9.5	28.6	88.9	9.5	47.7
101.6 (4")	1	44.5 (1 3/4")	M33x2	1 1/4 - 12	M39x2	1 1/2 - 12	–	55	50.8	60.30	36	42.9	6.4	25.4	88.9	9.5	47.7
	2	63.5 (2 1/2")	M48x2	1 7/8 - 12	M56x2	2 1/4 - 12	M42x2	–	76.2	79.35	55	60.3	9.5	34.9	114.3	15.9	57.2
	3	50.8 (2")	M39x2	1 1/2 - 12	M45x2	1 3/4 - 12	M42x2	–	57.1	66.65	41	49.2	6.4	28.6	101.6	15.9	50.8
127.0 (5")	1	50.8 (2")	M39x2	1 1/2 - 12	M45x2	1 3/4 - 12	–	62	57.1	66.65	41	49.2	6.4	28.6	101.6	15.9	50.8
	2	88.9 (3 1/2")	M64x2	2 1/2 - 12	M76x2	3 1/4 - 12	M48x2	–	88.9	107.92	75	85.7	9.5	34.9	146.1	15.9	57.2
	3	63.5 (2 1/2")	M48x2	1 7/8 - 12	M56x2	2 1/4 - 12	M48x2	–	76.2	79.35	55	60.3	9.5	34.9	114.3	15.9	57.2
	4	76.2 (3")	M58x2	2 1/4 - 12	M68x2	2 3/4 - 12	–	–	88.9	95.22	65	73.0	9.5	34.9	133.4	15.9	57.2
152.4 (6")	1	63.5 (2 1/2")	M48x2	1 7/8 - 12	M56x2	2 1/4 - 12	–	84	76.2	79.35	55	60.3	6.4	31.8	114.3	15.9	57.2
	2	101.6 (4")	M76x2	3 - 12	M95x2	3 3/4 - 12	M64x3	–	101.6	120.62	85	98.4	6.4	31.8	165.1	19.1	57.2
	3	76.2 (3")	M58x2	2 1/4 - 12	M68x2	2 3/4 - 12	–	–	88.9	95.22	65	73.0	6.4	31.8	133.4	15.9	57.2
	4	88.9 (3 1/2")	M64x2	2 1/2 - 12	M76x2	3 1/4 - 12	M64x3	–	88.9	107.92	75	85.7	6.4	31.8	146.1	15.9	57.2
177.8 (7")	1	76.2 (3")	M58x2	2 1/4 - 12	M68x2	2 3/4 - 12	–	–	88.9	95.22	65	73.0	6.4	31.8	133.4	15.9	57.2
	2	127.0 (5")	M90x2	3 1/2 - 12	M110x2	4 3/4 - 12	–	–	127.0	146.02	110	123.8	6.4	31.8	190.5	25.4	57.2
	3	88.9 (3 1/2")	M64x2	2 1/2 - 12	M76x2	3 1/4 - 12	–	–	88.9	107.92	75	85.7	6.4	31.8	146.1	15.9	57.2
	4	101.6 (4")	M76x2	3 - 12	M95x2	3 3/4 - 12	–	–	101.6	120.62	85	98.4	6.4	31.8	165.1	19.1	57.2
203.2 (8")	1	88.9 (3 1/2")	M64.2	2 1/2 - 12	M76x2	3 1/4 - 12	–	–	88.9	107.92	75	85.7	6.4	31.8	146.1	15.9	57.2
	2	139.7 (5 1/2")	M100x2	4 - 12	M130x2	5 1/4 - 12	–	–	139.7	158.72	120	136.5	6.4	31.8	209.6	19.1	57.2
	3	101.6 (4")	M76x2	3 - 12	M95x2	3 3/4 - 12	–	–	101.6	120.62	85	98.4	6.4	31.8	165.1	19.1	57.2
	5	127.0 (5")	M90x2	3 1/2 - 12	M110x2	4 3/4 - 12	–	–	127.0	146.02	110	123.8	6.4	31.8	190.5	25.4	57.2

<sup>1</sup> All rod threads are UNF except 1" - 14 which is UNS.

<sup>2</sup> Style 7 threads apply to spherical rod eyes only, see page 29.

All dimensions are in millimetres unless otherwise stated.

**Storage**

When cylinders must be stored for a period of time, the following procedures are recommended:

1. Store the cylinders in an indoor area which has a dry, clean and non-corrosive atmosphere. Take care to protect the cylinder from both internal corrosion and external damage.
2. Whenever possible, cylinders should be stored in a vertical position (piston rod up). This will minimize corrosion due to possible condensation which could occur inside the cylinder.
3. Port protector plugs should be left in the cylinder until the time of installation.

**Installation**

1. Cleanliness is an important consideration, and Parker cylinders are shipped with the ports plugged to protect them from contaminants entering the ports. These plugs should not be removed until the piping is to be installed. Before making the connection to the cylinder ports, piping should be thoroughly cleaned to remove all chips or burrs which might have resulted from threading or flaring operations.
2. Cylinders operating in an environment where air drying materials are present such as fast-drying chemicals, paint, or weld splatter, or other hazardous conditions such as excessive heat, should have shields installed to prevent damage to the piston rod and piston rod seals.
3. Correct alignment of the cylinder piston rod and its mating component on the machine should be checked in both the extended and retracted positions. Incorrect alignment will result in excessive rod gland and/or cylinder bore wear, shortening the life of the cylinder.

**Warranty**

**Defective Work or Material** Every effort is made to ensure sound material and good workmanship, but the Seller gives no warranty, expressed or implied, of material, workmanship, or fitness of goods for any particular purpose, whether such purpose be known to the Seller or not. In the event of any material or workmanship proving defective the Seller is prepared to rectify or replace such material at the place of delivery and in the condition originally specified, or if rectification or replacement is not practicable, will credit the value of the goods at the invoice price, if required in writing to do so, provided always that the claim is made and admitted and the material is returned within six months from date of invoice. The Seller's liability in respect of or consequent upon any such defect whether in original or replaced material or workmanship, is limited as aforesaid and does not extend in any circumstances to cover any other expenditure incurred nor any consequential damages or loss of profit.

**Masses – Series 2H Cylinders**

To determine the mass of the cylinder, first select the basic mass for zero stroke, then calculate the mass for the cylinder stroke and add the result to the basic mass.

Bore Ø	Rod No.	Single Rod Cylinders			Double Rod Cylinders		
		Mass at Zero Stroke		Mass per 10mm Stroke kg	Mass at Zero Stroke		Mass per 10mm Stroke kg
		Mounting Styles			Mounting Styles		
		TB, TC, TD, J, JB, H, HB, F kg	JJ, HH, D, DB, DD, C, G, SBa, BB kg	TB, TD, J, JB, F kg	JJ, C, G, D, DD kg		
38.1 (1½")	1	3.6	4.7	0.09	4.1	5.23	0.10
	2	3.7	4.9	0.11	4.4	5.53	0.15
50.8 (2")	1	5.7	7.5	0.14	6.9	8.74	0.18
	2	6.0	7.8	0.18	7.5	9.34	0.25
63.5 (2½")	1	7.9	10.1	0.19	9.4	11.7	0.23
	2	8.7	11.0	0.27	11.0	13.3	0.39
	3	8.2	10.8	0.22	10.0	12.7	0.30
82.6 (3¼")	1	15.2	19.4	0.31	18.2	22.5	0.39
	2	16.1	20.4	0.39	20.0	24.3	0.55
	3	15.7	19.9	0.36	19.2	23.5	0.48
101.6 (4")	1	20.4	25.7	0.39	25	31	0.51
	2	22.2	27.5	0.51	29	35	0.76
	3	20.8	26	0.42	26	32	0.58
127.0 (5")	1	36	44	0.59	43	52	0.75
	2	41	49	0.92	53	62	1.40
	3	37	46	0.68	46	55	0.93
	4	39	47	0.79	49	58	1.20
152.4 (6")	1	58	71	0.92	68	82	1.2
	2	64	77	1.3	80	94	2.0
	3	60	73	1.1	71	85	1.4
	4	62	75	1.2	74	88	1.7
177.8 (7")	1	86	105	1.2	99	119	1.5
	2	97	116	1.8	122	142	2.8
	3	88	107	1.3	103	123	1.8
	4	90	109	1.4	108	128	2.1
203.2 (8")	1	120	145	1.6	137	163	2.1
	2	135	160	2.3	166	192	3.5
	3	123	148	1.8	142	168	2.4
	5	130	155	2.1	157	183	3.1
254.0 (10")	1	275	328	3.0	325	378	4.0
	2	291	344	4.0	357	410	5.9
304.8 (12")	1	444	527	3.9	519	603	5.1
	2	474	557	5.6	579	663	8.4

Masses for accessories are shown on pages 27 to 29.

**Parker Offers the Widest Range of Industrial Cylinders**

**High Productivity – Low Cost of Ownership**

Parker Hannifin's Cylinder Division is the world's largest supplier of hydraulic cylinders for industrial applications.

Parker manufactures a vast range of standard and special tie rod, roundline and 'mill' type cylinders to suit all types of industrial cylinder applications. Our cylinders are available to ISO, DIN, NFPA, ANSI and JIC standards, with other certifications available on request. All Parker hydraulic cylinders are designed to deliver long, efficient service with low maintenance requirements, guaranteeing high productivity year after year.

**About Parker Hannifin**

Parker Hannifin Corporation is a world leader in the manufacture of components and systems for motion control. Parker has more than 800 product lines for hydraulic, pneumatic and electro-mechanical applications in some 1200 industrial and aerospace markets. With more than 50,000 employees and some 210 manufacturing plants and administrative offices around the world, Parker provides customers with technical excellence and first class customer service.

Visit us at [www.parker.com/uk](http://www.parker.com/uk)

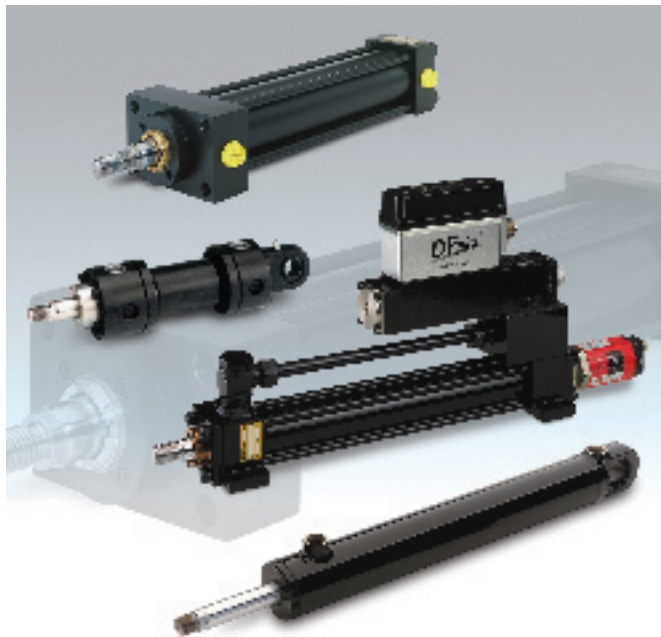

**Standard Specifications**

- Heavy-duty service – ANSI B93.15-1987 and NFPA specifications
- Standard construction – square end - tie rod design
- Standard pressure – 210 bar
- Standard fluid – hydraulic mineral oil
- Standard temperature – -20°C to 80°C (-4°F to 176°F)

**Contents**

	<b>Page</b>
Piston Rod End Data – 38.1mm to 203.2mm (1½" to 8") bores	3
Storage Information & Mass Data	4
Warranty	4
Introduction	5
Standard Specifications	5
Design Features and Benefits	6
Cylinder Selection Check List	8
Mounting Styles	9
Double Rod Cylinders	26
Accessories	27
Mounting Information	30
Push and Pull Forces	32
Piston Rod Sizes & Stop Tubes	33
Stroke Factors & Long Stroke Cylinders	34
Cushioning	35
Pressure Limitations	36
Ports, Locations and Piston Speeds	36
Seals & Fluids	38
Optional Features	39
Replacement Parts and Service	40
Repairs	41
Piston Rod End Data – 254.0mm and 304.8mm (10" and 12") bores	42
How to Order Cylinders	43

**The 2H Cylinder Range**

The 2H cylinders described in this catalogue are heavy duty hydraulic cylinders, rated for use at working pressures up to 210 bar depending on the rod end and type of service.

In addition to the standard cylinders featured in this catalogue, 2H cylinders can be designed to suit customer requirements. Our engineers will be pleased to advise on unique designs to suit specific applications.

**inPHorm and 3-D CAD**

Parker offers easy-to-use software to simplify the cylinder selection process, saving your time and ensuring the accuracy of designs and drawings. InPHorm selection software and new 3-D CAD modelling software can be downloaded from our European Cylinder Division website. Please visit us at [www.parker.com/eu](http://www.parker.com/eu) or contact your local Sales Office for more information.

- Bore sizes – 38.1mm (1½") to 304.8mm (12")
- Piston rod diameters – 15.9mm (5/8") to 215.9mm (8½")
- Mounting styles – 17 standard styles
- Strokes – available in any practical stroke length
- Cushions – optional at either end or both ends of stroke
- Rod ends – three standard choices – specials to order

Note: In line with our policy of continuing product improvement, specifications in this catalogue are subject to change without notice.

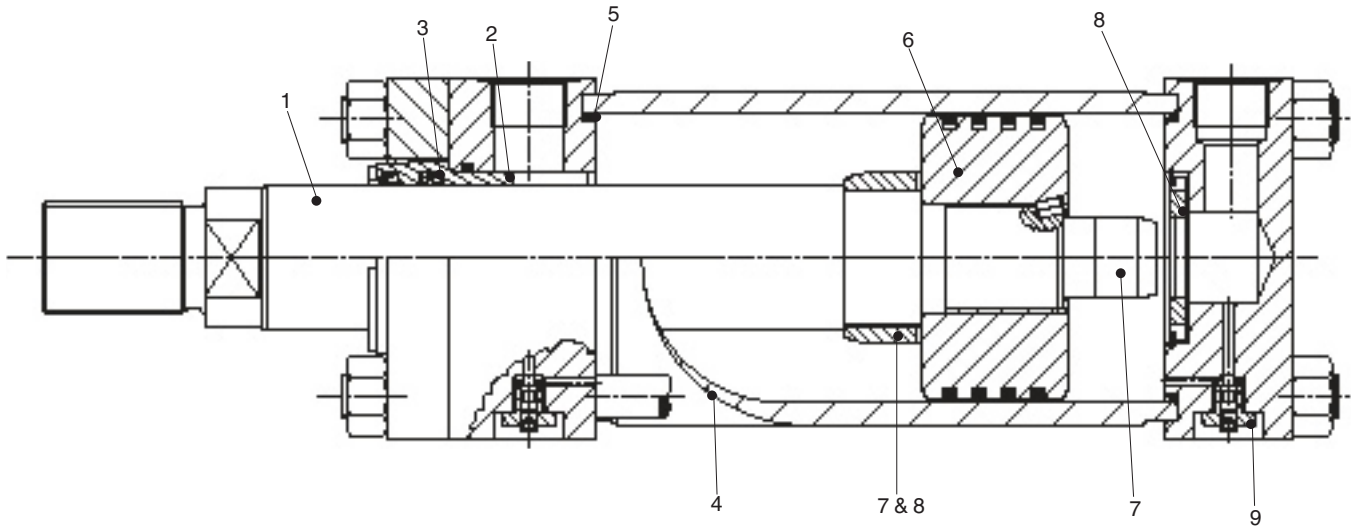

**1 Piston Rod**

Gland seal life is maximised by manufacturing piston rods from precision ground, high tensile carbon alloy steel, hard chrome plated and polished to 0.2µm max. Piston rods are induction case hardened to Rockwell C54 minimum before chrome plating, resulting in a dent-resistant surface.

**2 Parker's Rod Gland**

Continuous lubrication, and therefore longer gland life, are provided by the long bearing surface inboard of the lipseal. The gland, complete with rod seals, can easily be removed without dismantling the cylinder, so servicing is quicker – and therefore more economical.

**3 Rod Seals**

The serrated lipseal has a series of sealing edges which take over successively as pressure increases, providing efficient sealing under all operating conditions. On the return stroke the serrations act as a check valve, allowing the oil adhering to the rod to pass back into the cylinder.

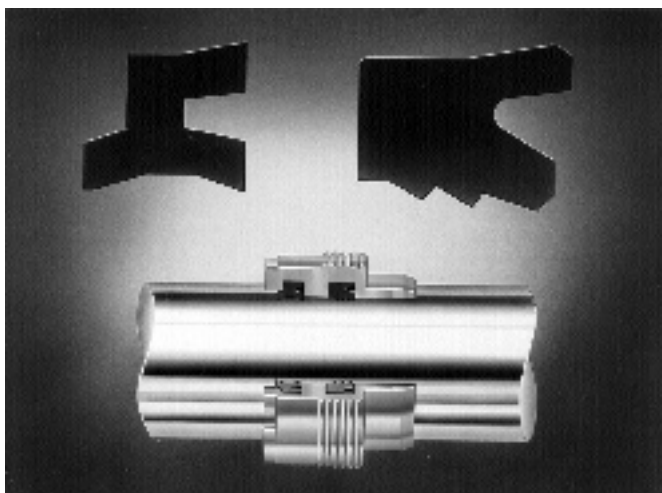

The double lip wiperseal acts as a secondary seal, trapping excess lubricating film in the chamber between the wiper and lip seals and preventing the ingress of dirt into the cylinder, extending the life of gland and seals. Standard lipseals are manufactured from an enhanced polyurethane, giving efficient retention of fluid

and a life of up to five times that of traditional seal materials. Standard seals are suitable for speeds up to 0.5m/s – special seal combinations are available for higher speed applications.

**4 Cylinder Body**

Strict quality control standards and precision manufacture ensure that all tubes meet rigid standards of straightness, roundness and surface finish. The steel tubing is surface finished to minimise internal friction and prolong seal life.

**5 Cylinder Body Seals**

To ensure that the cylinder body remains leak free, even under pressure shock conditions, Parker fits pressure-energised body seals.

**6 Piston**

Wear-resistant cast iron piston rings pistons are fitted as standard to 2H cylinders. Lipseal and Hi-Load pistons are available to suit different applications – see 'Piston Seals' opposite. All pistons are of one-piece type, and feature wide bearing surfaces to resist side loading. Long thread engagement secures the piston to the piston rod and, for additional safety, the piston is secured by thread-locking adhesive and a locking pin.

**7 Cushioning**

Progressive deceleration is available by using stepped cushions at the head and cap – see page 35 for details. The head and cap end cushions are self centring. The polished cap end spear is an integral part of the piston rod.

**8 Floating Cushion Bushes & Sleeves**

Closer tolerances – and therefore more effective cushioning – are permitted by the use of a floating cushion sleeve at the head end of the cylinder, and a floating cushion bush at the cap end. A specially designed cushion sleeve on bore sizes up to 101.6mm (4") operates as a check valve. On larger bore sizes a conventional ball check valve is used. The use of a check valve in the head and lifting of the bronze cushion bush in the cap, provides minimum fluid flow restriction at the start of the return stroke. This allows full pressure to be applied over the whole area of the piston, to provide full power and fast cycle times.

**9 Cushion Adjustment**

Needle valves are provided at both ends of the cylinder for precise cushion adjustment, and retained within the head and cap so that they cannot be inadvertently removed. The cartridge type needle valve illustrated below is fitted to cylinders of up to 63.5mm (2 1/2") bore – see page 37.

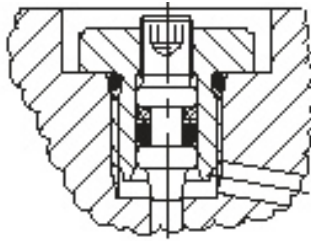

**Air Bleeds**

Available as an option at both ends, the air bleeds are recessed into the head and cap and retained so that they cannot be inadvertently removed. See Optional Features, page 39.

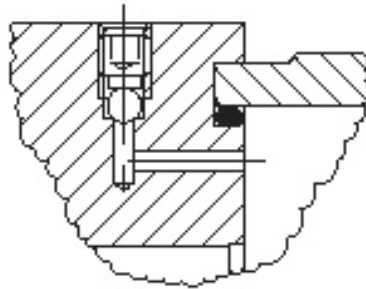

**Gland Drains**

The accumulation of fluid behind the gland wiperseal of long stroke cylinders, or cylinders with constant back pressure, can be relieved by specifying the option of a gland drain. A port between the wiperseal and lipseal allows fluid to be piped back to a reservoir. By fitting a transparent tube between the port and the reservoir, fluid loss from concealed or inaccessible cylinders can be monitored to provide an early indication of the need for gland servicing. Gland drains are described in greater detail on page 39.

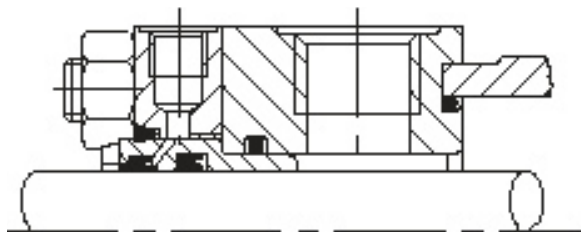

**Special Designs**

Parker's design and engineering staff are available to produce special designs to meet customer's specific requirements. Alternative sealing arrangements, special mounting styles, different bores and rod sizes are just a few of the custom features which can be supplied.

**Piston Seals**

A variety of piston seal options is available, to suit different applications. The seal option should be specified at the time of order as a seal type cannot be changed unless the piston is also changed.

**Cast Iron Piston Rings** are extremely durable but allow some leakage across the piston and cannot therefore hold a load in position. Piston rings are fitted as standard on series 2H hydraulic cylinders.

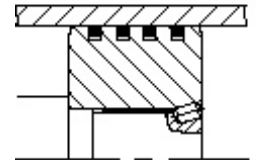

**Lipseal Pistons** can hold a load in position, but they are not as durable as piston rings. Lipseal pistons are optional on series 2H hydraulic cylinders.

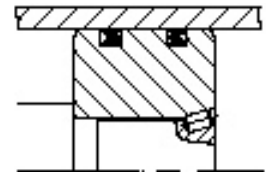

**Hi-Load Pistons** resist side loading and are recommended for long stroke cylinders, especially when pivot mounted. Special wear rings prevent metal to metal contact between the piston and tube and thereby extend the life of the cylinder.

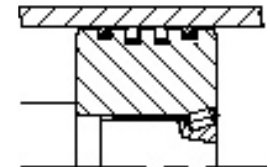

**Seal Classes**

To accommodate the many types of fluid and the varying temperature ranges used in industry, Parker offers a range of rod gland, piston and body seals moulded in different profiles and from different materials. These are described in detail on page 38.

**Low Friction Seals**

Low friction seals are also available. Please consult the factory.

**Cylinder Construction**

The dimensional drawings on pages 22-25 show 254mm (10") bore models only, but can also be used to determine all pertinent dimensional data for 304.8mm (12") bore models which are designed with 16 tie rods.

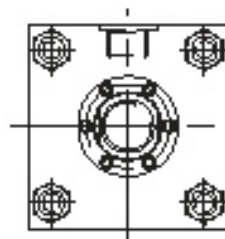

254mm (10") Bore Design  
 4 Tie Rod Construction

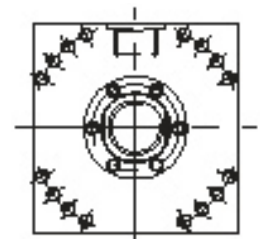

304.8mm (12") Bore Design  
 16 Tie Rod Construction

**Check List**

The following check list indicates the principal factors which should be considered when selecting a hydraulic cylinder for a particular application. Further information is available on the

pages shown. If more detailed information is required about any aspect of a cylinder's specification, please contact our design engineers who will be happy to assist.

- 1 Establish System Parameters** ..... **Series 2H**
  - Weight to be moved and force required
  - Nominal operating pressure and range
  - Distance to be travelled
  - Average and maximum piston speed
  - Fluid medium and temperature
  
- 2 Mounting Style**..... **Page 9**  
 Select the appropriate style for the specific application
  
- 3 Cylinder Bore and Operating Pressure**..... **Pages 32, 36**  
 Determine the bore and system pressure required to provide the necessary force
  
- 4 Piston Rod** ..... **Pages 3, 26, 33, 36, 42**  
 Single or double rod?  
 Determine the minimum rod diameter required to withstand buckling forces  
 Is a stop tube required?  
 Select a suitable rod end and rod end thread  
 Check pressure rating of selected cylinder and piston rod
  
- 5 Piston**..... **Page 7**  
 Does seal type suit application?
  
- 6 Cushioning** ..... **Page 35**  
 Select cushioning requirements if applicable
  
- 7 Ports** ..... **Pages 36, 37**  
 Select suitable ports  
 Are they capable of the speed required?  
 Are the standard positions acceptable?
  
- 8 Seals** ..... **Pages 7, 38**  
 Select seals to suit the chosen fluid medium and temperature range
  
- 9 Rod and Cap End Accessories**..... **Pages 27, 28, 29**  
 Are rod end and/or cap end accessories required?
  
- 10 Optional Features** ..... **Page 39**  
 Air bleeds, gland drains, rod end bellows etc.



**Mounting Styles and Where to Use Them**

See also application-specific mounting information on pages 30-31.

**Extended Tie Rod Mountings – Styles TB, TC and TD**

**Application**

- straight line force transfer
- compression (push) – use cap end mountings TC or TD
- tension (pull) – use head end mountings TB or TD

**Benefits**

- ease of mounting where space is limited
- high efficiency – force is absorbed on cylinder's centreline
- TD double-ended mounting allows brackets or switches to be attached to cylinder

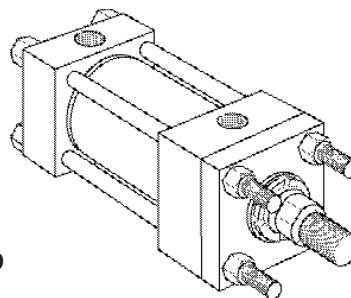

**Styles TB, TC, TD**  
See pages 10-11

TB

**Flange Mountings – Styles J, JB, JJ, H, HB and HH**

**Application**

- straight line force transfer
- compression (push) – use cap end mounting H, HB or HH
- tension (pull) – use head end mounting J, JB or JJ

**Benefits**

- exceptionally rigid mounting due to large flange area
- high efficiency – force is absorbed on cylinder's centreline

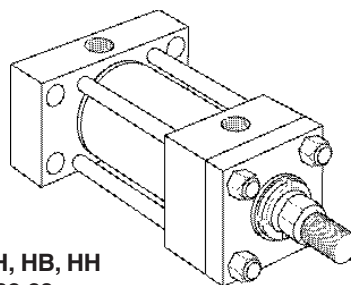

**Styles J, JB, JJ, H, HB, HH**  
See pages 12-15, 22-23

HH

**Foot Mountings – Style C, F, G**

**Application**

- straight line force transfer
- suitable for push or pull applications
- force is **not** absorbed on centreline – secure attachment, eg: a thrust key (page 30) and effective load guidance are vital

**Benefits**

- ease of mounting and adjustment

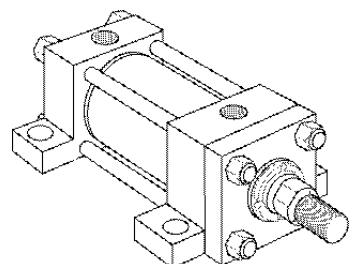

**Styles C, F, G**  
See pages 16-17 and 25

C

**Pivot Mountings – Styles BB and SBa**

**Application**

- curved path force transfer
- movement in a single plane – use fixed clevis style BB
- movement in more than one plane – use spherical bearing style SBd

**Benefits**

- ease of attachment – use with plain or spherical bearing at rod end
- greater flexibility for the machine designer
- self-alignment resists wear of cylinder's bearing surfaces

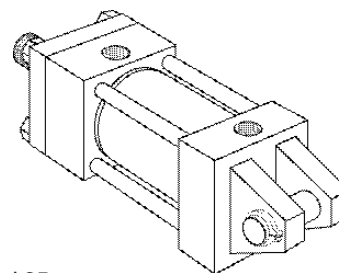

**Styles BB, SBa**  
See pages 18-19 and 25

BB

**Trunnion Mountings – Styles D, DB and DD**

**Application**

- curved path force transfer
- movement in a single plane
- compression (push) – use DB or DD mountings
- tension (pull) – use D or DD mountings

**Benefits**

- greater flexibility for the machine designer
- self-alignment resists wear of cylinder's bearing surfaces
- high efficiency – force is absorbed on cylinder's centreline
- ease of attachment – use with pivot mounting at rod end

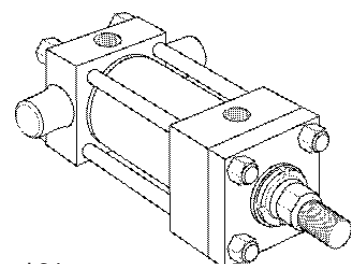

**Styles D, DB, DD**  
See pages 20-21 and 24

DB

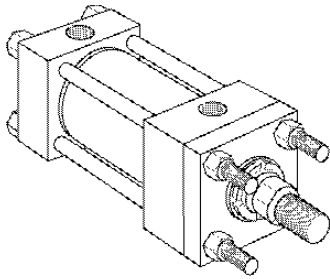

**Style TB**  
Tie Rods Extended Head End  
(NFPA Style MX3)

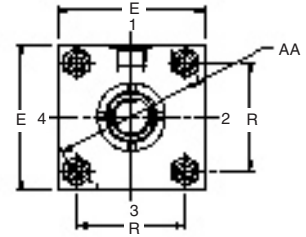
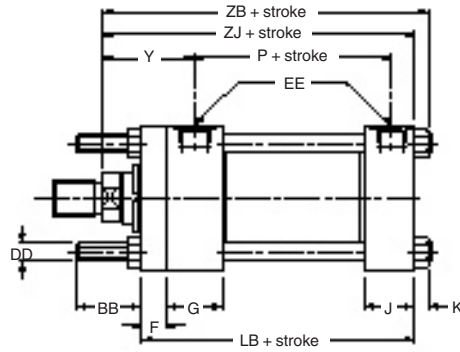

otes 1, 2

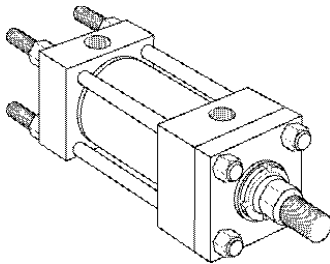

**Style TC**  
Tie Rods Extended Cap End  
(NFPA Style MX2)

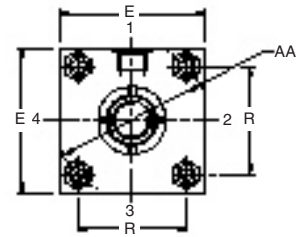
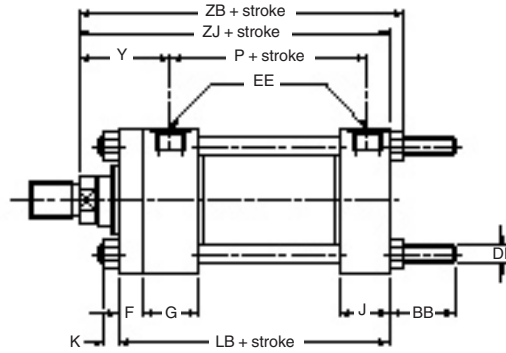

otes 1, 2

**Dimensions TB, TC & TD** See also Dimensions, page 3 & Mounting Information, page 30

Bore Ø	Rod No.	AA	BB	DD <sup>1</sup>	E	EE (BSPP)	F	G	J
38.1 (1½")	1	58.4	34.9	¾ - 24	63.5	G½	9.5	44.5	38.1
	2								
50.8 (2")	1	73.7	46.0	½ - 20	76.2	G½	15.9	44.5	38.1
	2								
63.5 (2½")	1	91.4	46.0	½ - 20	88.9	G½	15.9	44.5	38.1
	2								
	3								
82.6 (3¼")	1	116.8	58.7	⅝ - 18	114.3	G¾	19.1	50.8	44.5
	2								
	3								
101.6 (4")	1	137.2	58.7	⅝ - 18	127.0	G¾	22.2	50.8	44.5
	2								
	3								
127.0 (5")	1	177.8	81.0	⅞ - 14	165.1	G¾	22.2	50.8	44.5
	2								
	3								
	4								
152.4 (6")	1	205.7	92.1	1 - 14	190.5	G1	25.4	57.2	57.2
	2								
	3								
	4								
177.8 (7")	1	236.2	104.8	1⅛ - 12	215.9	G1¼	25.4	69.9	69.9
	2								
	3								
	4								
203.2 (8")	1	269.2	114.3	1¼ - 12	241.3	G1½	25.4	76.2	76.2
	2								
	3								
	5								

All dimensions are in millimetres unless otherwise stated.

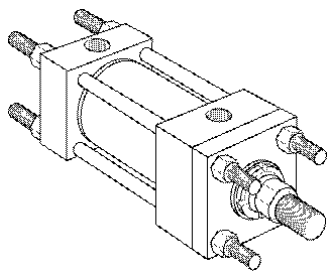

**Style TD**  
Tie Rods Extended Both Ends  
(NFFA Style MX1)

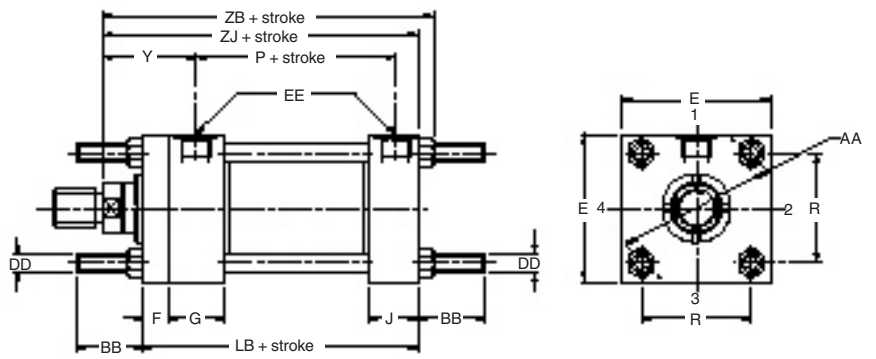

SEE NOTES 1, 2

**Notes**

- 1 All tie rod threads (dimension DD) are UNF, with the exception of 1" - 14 which is UNS
- 2 Mounting nuts should be tightened to the torque values shown for tie rod nuts – see page 31

**Dimensions TB, TC & TD Continued**

Bore Ø	Rod No.	K max	R	Y	+ Stroke					
					LB	P	ZB max	ZJ		
38.1 (1½")	1	10	41.4	49	127.0	75	152.4	142.9		
	2			59			161.9	152.4		
50.8 (2")	1	13	52.1	59	133.4	75	163.5	152.4		
	2			65			169.9	158.8		
63.5 (2½")	1	13	64.8	59	136.5	78	166.7	156.6		
	2			71			179.4	168.3		
	3			65			173.3	161.9		
82.6 (3¼")	1	16	82.6	68	158.8	90	195.3	181.0		
	2			79			204.8	190.5		
	3			76			201.6	187.3		
101.6 (4")	1	16	97.0	76	168.3	97	208.0	193.7		
	2			86			217.5	203.2		
	3			79			211.1	196.9		
127.0 (5")	1	19	125.7	79	181.0	110	230.2	209.6		
	2			86			236.5	215.9		
	3			86			236.5	215.9		
	4			86			236.5	215.9		
152.4 (6")	1	23	145.5	86	212.7	130	266.7	244.5		
	2									
	3									
	4									
177.8 (7")	1	26	167.1	92	241.3	146	298.5	273.0		
	2									
	3									
	4									
203.2 (8")	1	28	190.5	94	266.7	168	325.4	298.4		
	2									
	3									
	5									

All dimensions are in millimetres unless otherwise stated.

**Head Flange Mountings 38.1 - 203.2mm bores 2H Series**

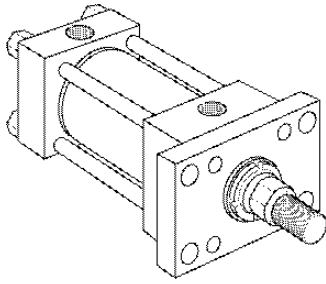

**Style J**  
Head Rectangular Flange  
(NFPA Style MF1)

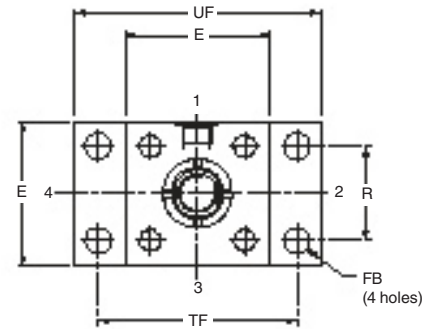
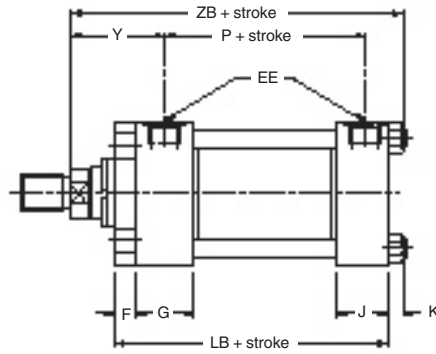

SEE NOTE 1

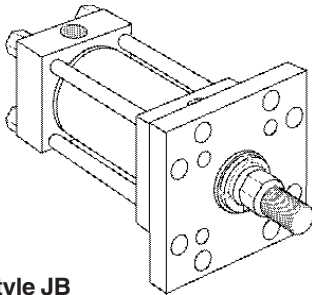

**Style JB**  
Head Square Flange  
(NFPA Style MF5)

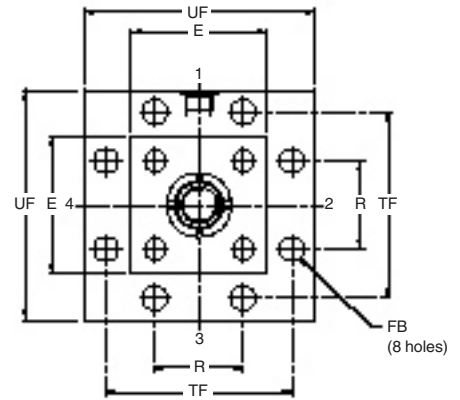
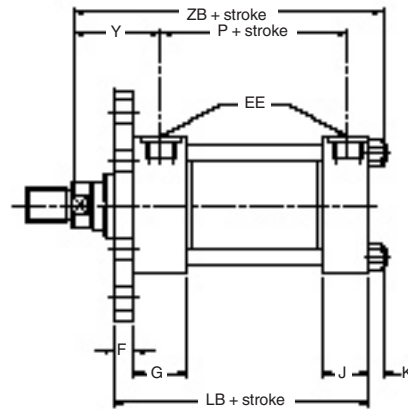

**Dimensions J, JB & JJ** See also Dimensions, page 3 & Mounting Information, pages 30 & 36

Bore Ø	Rod No.	E	EE (BSP)	F	FB	G	J	K	KB	R
38.1 (1½")	1	63.5	G½	9.5	11.1	44.5	38.1	10	0.0	41.4
	2									
50.8 (2")	1	76.2	G½	15.9	14.3	44.5	38.1	13	0.0	52.1
	2									
63.5 (2½")	1	88.9	G½	15.9	14.3	44.5	38.1	13	0.0	64.8
	2									
	3									
82.6 (3¼")	1	114.3	G¾	19.1	17.5	50.8	44.5	16	6.4	82.6
	2									
	3									
101.6 (4")	1	127.0	G¾	22.2	17.5	50.8	44.5	16	6.4	97.0
	2									
	3									
127.0 (5")	1	165.1	G¾	22.2	23.8	50.8	44.5	19	3.2	125.7
	2									
	3									
	4									
152.4 (6")	1	190.5	G1	25.4	27.0	57.2	57.2	22	6.4	145.5
	2									
	3									
	4									
177.8 (7")	1	215.9	G1¼	25.4	30.2	69.9	69.9	24	6.4	167.1
	2									
	3									
	4									
203.2 (8")	1	241.3	G1½	25.4	33.3	76.2	76.2	27	6.4	190.5
	2									
	3									
	4									
	5									

All dimensions are in millimetres unless otherwise stated.

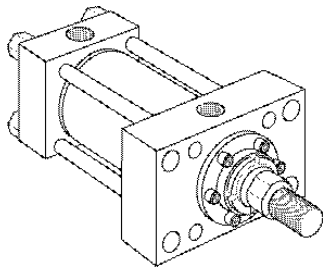

**Style JJ**  
Rectangular Head  
(NFFA Style ME5)

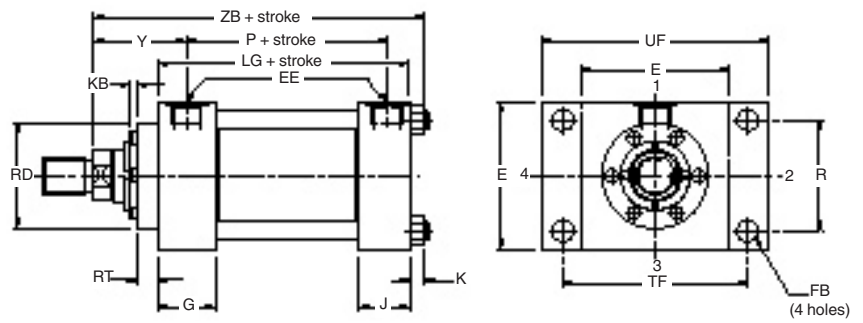

**Notes**

1 For maximum pressure ratings in push applications, see page 36

**Dimensions J, JB & JJ Continued**

Bore Ø	Rod No.	RD max	RT	TF	UF	Y	+ Stroke			
							LB	LG	P	ZB max
38.1 (1½")	1	54.0	9.5			49				152.4
	2	63.5	9.5	87.3	108.0	59	127.0	117.5	75	161.9
50.8 (2")	1	63.5	9.5			59				163.5
	2	76.2	9.5	104.8	130.2	65	133.4	117.5	75	169.9
63.5 (2½")	1	63.5	9.5			59				166.7
	2	88.9	9.5	117.5	142.9	71	136.5	120.7	78	179.4
	3	76.2	9.5			65				173.3
82.6 (3¼")	1	76.2	9.5			68				195.3
	2	101.6	15.9	149.2	181.0	79	158.8	139.7	90	204.8
	3	88.9	9.5			76				201.6
101.6 (4")	1	88.9	9.5			76				208.0
	2	114.3	15.9	161.9	193.7	86	168.3	146.1	97	217.5
	3	101.6	15.9			79				211.1
127.0 (5")	1	101.6	15.9			79				230.2
	2	146.1	15.9			86				236.5
	3	114.3	15.9	208.0	247.7	86	181.0	158.8	110	236.5
	4	133.4	15.9			86				236.5
152.4 (6")	1	114.3	15.9							
	2	165.1	19.1							
	3	133.4	15.9	239.7	285.8	86	212.7	187.3	130	266.7
	4	146.1	15.9							
177.8 (7")	1	133.4	15.9							
	2	190.5	25.4							
	3	146.1	15.9	269.9	320.7	92	241.3	215.9	146	298.5
	4	165.1	19.1							
203.2 (8")	1	146.1	15.9							
	2	209.6	19.1							
	3	165.1	19.1	300.0	355.6	94	266.7	241.3	168	325.4
	5	190.5	25.4							

All dimensions are in millimetres unless otherwise stated.

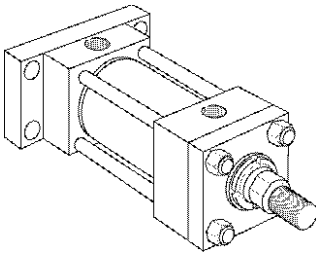

**Style H**  
Cap Rectangular Flange  
(NFFPA Style MF2)

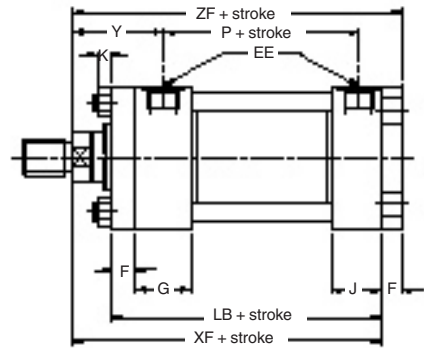
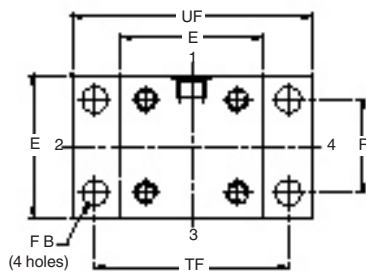

lote 1

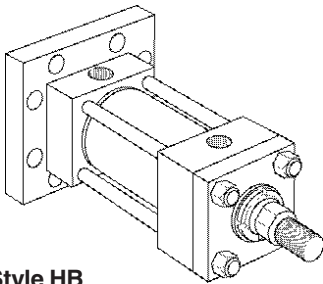

**Style HB**  
Cap Square Flange  
(NFFPA Style MF6)

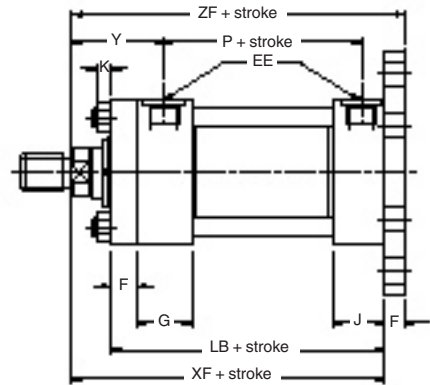
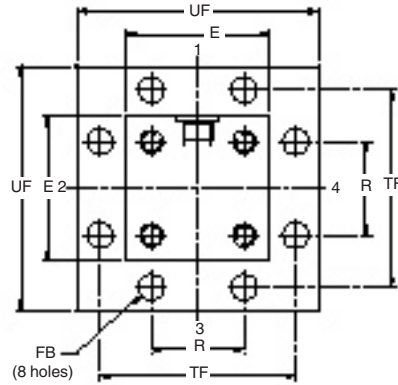

**Dimensions H, HB & HH** See also Dimensions, page 3 & Mounting Information, pages 30 & 36

Bore Ø	Rod No.	E	EE (BSPP)	F	FB	G	J	K	R
38.1 (1½")	1	63.5	G½	9.5	11.1	44.5	38.1	10	41.4
	2								
50.8 (2")	1	76.2	G½	15.9	14.3	44.5	38.1	13	52.1
	2								
63.5 (2½")	1	88.9	G½	15.9	14.3	44.5	38.1	13	64.8
	2								
	3								
82.6 (3¼")	1	114.3	G¾	19.1	17.5	50.8	44.5	16	82.6
	2								
	3								
101.6 (4")	1	127.0	G¾	22.2	17.5	50.8	44.5	16	97.0
	2								
	3								
127.0 (5")	1	165.1	G¾	22.2	23.8	50.8	44.5	19	125.7
	2								
	3								
	4								
152.4 (6")	1	190.5	G1	25.4	27.0	57.2	57.2	22	145.5
	2								
	3								
	4								
177.8 (7")	1	215.9	G1¼	25.4	30.2	69.9	69.9	24	167.1
	2								
	3								
	4								
203.2 (8")	1	241.3	G1½	25.4	33.3	76.2	76.2	27	190.5
	2								
	3								
	5								

All dimensions are in millimetres unless otherwise stated.

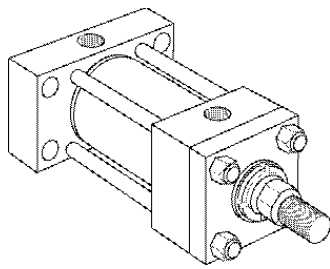

**Style HH**  
Rectangular Cap  
(NFFPA Style ME6)

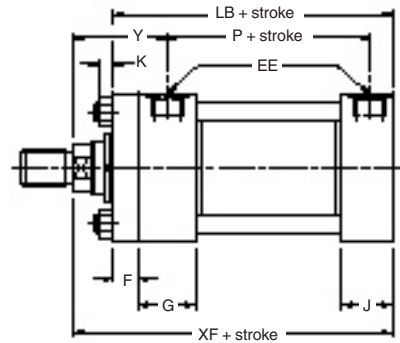
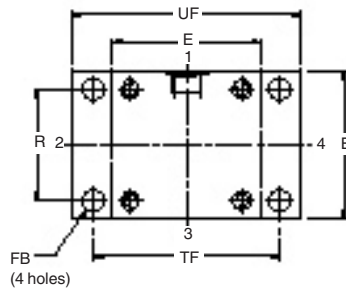

**Notes**

1 For maximum pressure ratings in pull applications, see page 36

**Dimensions H, HB & HH Continued**

Bore Ø	Rod No.	TF	UF	Y	+ Stroke													
					LB	P	XF	ZF										
38.1 (1½")	1	87.3	108.0	49	127.0	75	142.9	152.4										
	2			59			152.4	161.9										
50.8 (2")	1	104.8	130.2	59	133.4	75	152.4	168.3										
	2			65			158.8	174.6										
63.5 (2½")	1	117.5	142.9	59	136.5	78	156.6	171.5										
	2			71			168.3	184.2										
	3			65			161.9	177.8										
82.6 (3¼")	1	149.2	181.0	68	158.8	90	181.0	200.0										
	2			79			190.5	209.6										
	3			76			187.3	206.4										
101.6 (4")	1	161.9	193.7	76	168.3	97	193.7	215.9										
	2			86			203.2	225.4										
	3			79			196.9	219.1										
127.0 (5")	1	208.0	247.7	79	181.0	110	209.6	231.8										
	2			86			215.9	238.1										
	3			86			215.9	238.1										
	4			86			215.9	238.1										
152.4 (6")	1	239.7	285.8	86	212.7	130	244.5	269.9										
	2			86					212.7	130	244.5	269.9						
	3												86	212.7	130	244.5	269.9	
	4																	86
1	269.9	320.7	92		241.3	146	273.0	298.5										
2				92					241.3	146	273.0	298.5						
3													92	241.3	146	273.0	298.5	
4																		92
203.2 (8")	1	300.0	355.6		94	266.7	168	298.5										
	2			94					266.7	168	298.5	323.9						
	3												94	266.7	168	298.5	323.9	
	5																	94

All dimensions are in millimetres unless otherwise stated.

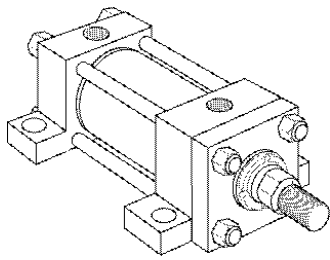

**Style C**  
Side Lug Mounting  
(NFPA Style MS2)

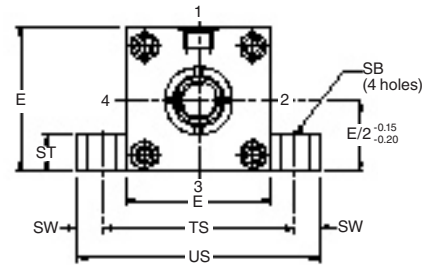
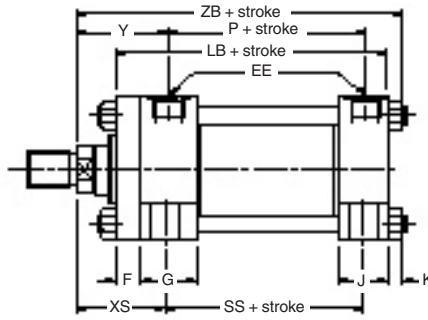

1, 3, 4

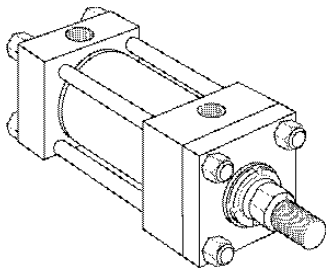

**Style F**  
Side Tapped Mounting  
(NFPA Style MS4)

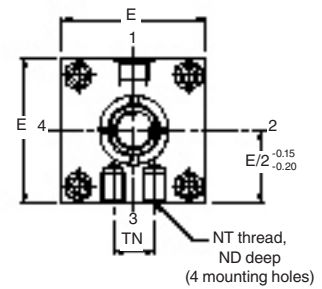
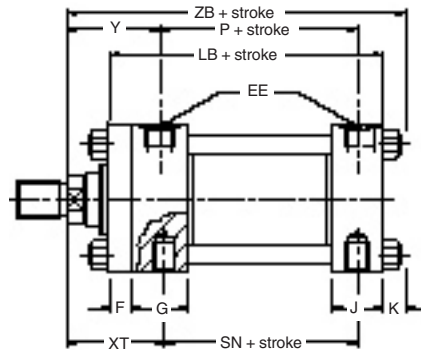

Notes 1, 2

**Dimensions C, F & G** See also Dimensions, page 3 & Mounting Information, page 30

Bore Ø	Rod No.	E	EB	EE (BSPP)	EL	EO	ES	ET	F	G	J	K	ND	NT <sup>2</sup>	R	SB <sup>3</sup>	ST
38.1 (1½")	1	63.5	11.5	G½	22.2	9.5	24	21	9.5	44.5	38.1	10	12	M10	41.4	11	12.7
	12																
50.8 (2")	1	76.2	14.3	G½	23.8	12.7	24	24	15.9	44.5	38.1	13	15	M12	52.1	14	19.1
	11																
63.5 (2½")	1	88.9	14.3	G½	23.8	12.7	24	24	15.9	44.5	38.1	13	14	M16	64.8	22	25.4
	2												12				
	3												14				
82.6 (3¼")	1	114.3	17.5	G¾	28.6	15.9	32	31	19.1	50.8	44.5	16	22	M20	82.6	22	25.4
	2												17				
	3												22				
101.6 (4")	1	127.0	17.5	G¾	28.6	15.9	32	29	22.2	50.8	44.5	16	25	M24	97.0	26	31.8
	2												17				
	3												25				
127.0 (5")	1	165.1	23.8	G¾	38.1	19.1	38	38	22.2	50.8	44.5	19	28	M24	125.7	26	31.8
	2												25				
	3												28				
	4												28				
152.4 (6")	1	190.5	27.0	G1	42.9	22.2	45	45	25.4	57.2	57.2	22	44	M30	145.5	33	38.1
	2												31				
	3												44				
	4												38				
177.8 (7")	1	215.9	30.2	G1¼	46.0	25.4	50	48	25.4	69.9	69.9	24	54	M42	167.1	39	44.5
	2												28				
	3												54				
	4												44				
203.2 (8")	1	241.3	33.3	G1½	50.8	28.6	50	48	25.4	76.2	76.2	27	57	M42	190.5	39	44.5
	2												38				
	3												57				
	5												44				

All dimensions are in millimetres unless otherwise stated.



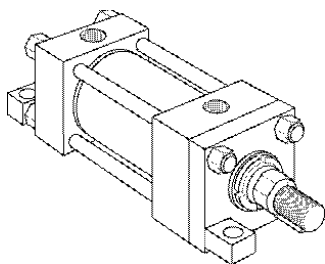

**Style G**  
Side End Lug  
(NFPA Style MS7)

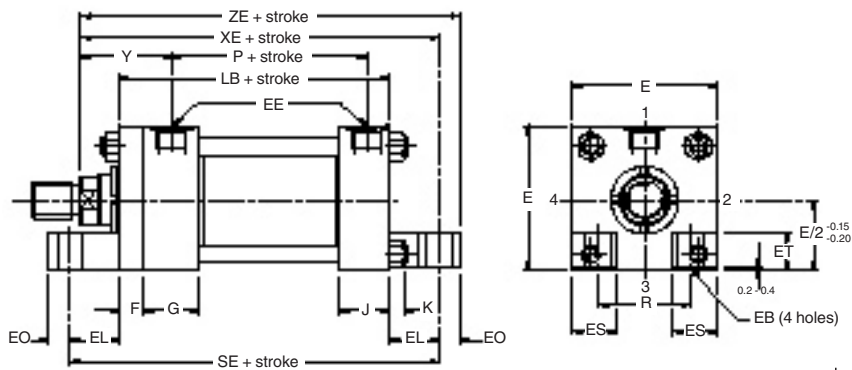

... lote 1

**Notes**

- 1 Consider the use of a thrust key with this mounting – see page 30
- 2 Tapped mounting holes are metric (coarse pitch series)
- 3 Upper surfaces of lugs are machined for socket head screws
- 4 Style C cylinders can be supplied with the cylinder ports arranged for mounting and sealing to a manifold surface – see page 31

**Dimensions C, F & G Continued**

Bore Ø	Rod No.	sw	TN	TS	US	XS	XT	Y	+ Stroke																							
									LB	P	SE	SN	SS	XE	ZB max	ZE																
38.1 (1½")	1	9.5	18.0	82.6	101.6	34.9	50.8	49	127.0	75	171.5	73.0	98.4	165.1	152.4	174.6																
	2																44.5	60.3	59	174.6	161.9	184.2										
50.8 (2")	1	12.7	23.8	101.6	127.0	47.6	60.3	59	133.4	75	181.0	73.0	92.1	176.2	163.5	188.9																
	2																54.0	66.7	65	182.6	169.9	195.3										
63.5 (2½")	1	17.5	32.0	123.8	158.8	52.4	60.3	59	136.5	78	184.2	76.2	85.7	179.4	166.7	192.1																
	2																65.1	73.0	71	192.1	179.4	204.8										
	3																58.7	66.7	65	185.7	173.3	198.4										
82.6 (3¼")	1	17.5	38.1	149.2	184.2	58.7	69.9	68	158.8	90	215.9	88.9	104.8	209.6	195.3	225.4																
	2																68.3	79.4	79	219.1	204.8	235.0										
	3																65.1	76.2	76	215.9	201.6	231.8										
101.6 (4")	1	22.2	52.4	171.5	215.9	69.9	76.2	76	168.3	97	225.4	95.3	101.6	222.3	208.0	238.1																
	2																79.4	85.7	86	231.8	217.5	247.7										
	3																73.0	79.4	79	225.4	211.1	241.3										
	4																73.0	79.4	79	247.7	230.2	266.7										
127.0 (5")	1	22.2	74.6	209.6	254.0	79.4	85.7	86	181.0	110	257.2	108.0	114.3	254.0	236.5	273.1																
	2																79.4	85.7	86	254.0	236.5	273.1										
	3																79.4	85.7	86	254.0	236.5	273.1										
	4																79.4	85.7	86	254.0	236.5	273.1										
152.4 (6")	1	28.6	84.1	247.7	304.8	85.7	88.9	86	212.7	130	298.5	130.2	130.2	287.3	266.7	309.6																
	2																241.3	146	333.4	149.2	146.1	319.1	298.5	344.5								
	3																								266.7	168	368.3	168.3	171.5	349.3	325.4	377.8
	4																															
177.8 (7")	1	34.9	90.0	285.8	355.6	92.1	96.8	92	241.3	146	333.4	149.2	146.1	319.1	298.5	344.5																
	2																266.7	168	368.3	168.3	171.5	349.3	325.4	377.8								
	3																								266.7	168	368.3	168.3	171.5	349.3	325.4	377.8
	4																															
203.2 (8")	1	34.9	105.0	311.2	381.0	92.1	100.0	94	266.7	168	368.3	168.3	171.5	349.3	325.4	377.8																
	2																266.7	168	368.3	168.3	171.5	349.3	325.4	377.8								
	3																								266.7	168	368.3	168.3	171.5	349.3	325.4	377.8
	5																															

All dimensions are in millimetres unless otherwise stated.



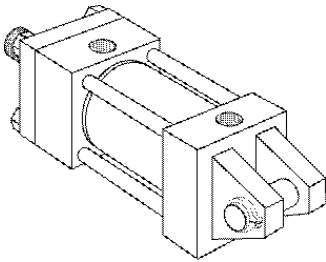

**Style BB**  
Cap Fixed Clevis  
(NFPA Style MP1)

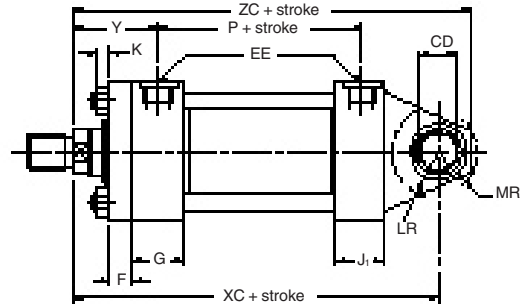
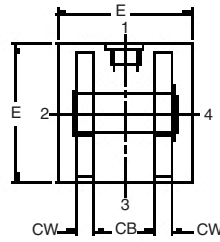

See Note 1

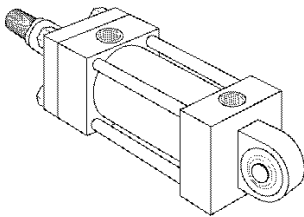

**Style SBa**  
Spherical Bearing  
(ISO 6982 and CETOP RP88H)

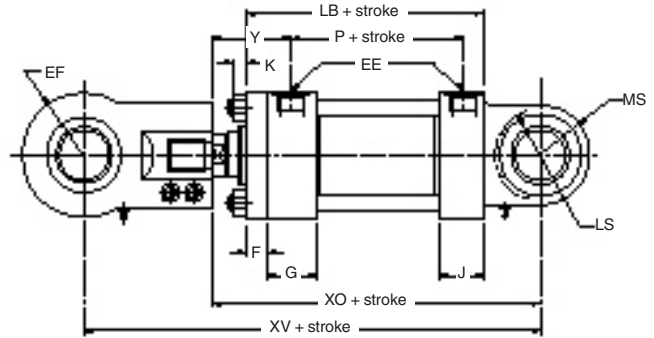
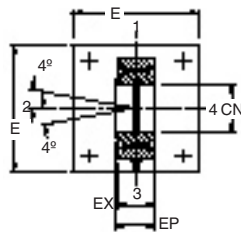

See Notes 2, 3, 4, 5

**Dimensions BB & SBa** See also Dimensions, page 3 & Mounting Information, page 30

Bore Ø	Rod No.	CB	CD <sup>+0.00</sup> / <sub>-0.05</sub>	CN H7	CW	E	EE (BSPP)	EF max	EP	EX	F	G	J	J <sub>1</sub>
38.1 (1½")	1	19.8	12.73	20	12.7	63.5	G½	25	20	18	9.5	44.5	38.1	42
	2													
50.8 (2")	1	32.5	19.08	25	15.9	76.2	G½	31	25	22	15.9	44.5	38.1	42
	2													
63.5 (2½")	1	32.5	19.08	32	15.9	88.9	G½	38	32	28	15.9	44.5	38.1	42
	2													
	3													
82.6 (3¼")	1	38.9	25.43	40	19.1	114.3	G¾	49	40	35	19.1	50.8	44.5	50
	2													
	3													
101.6 (4")	1	51.6	34.95	50	25.4	127.0	G¾	59	50	40	22.2	50.8	44.5	50
	2													
	3													
127.0 (5")	1	65.0	44.48	63	31.8	165.1	G¾	71	63	52	22.2	50.8	44.5	50
	2													
	3													
	4													
152.4 (6")	1	65.0	50.83	80	31.8	190.5	G1	90	80	60	25.4	57.2	57.2	61
	2													
	3													
	4													
177.8 (7")	1	77.8	63.53	-	38.1	215.9	G1¼	-	-	-	25.4	69.9	69.9	74
	2													
	3													
	4													
203.2 (8")	1	77.8	76.23	-	38.1	241.3	G1½	-	-	-	25.4	76.2	76.2	78
	2													
	3													
	5													

All dimensions are in millimetres unless otherwise stated.

**Notes**

- 1 Supplied complete with pivot pin
- 2 Maximum pressure rating 160 bar
- 3 For matching pin sizes specify rod end Style 7, see pages 3 and 29
- 4 Pivot pin not supplied
- 5 For spherical bearing mountings on cylinders above 152.4mm (6") bore, please consult the factory

**Dimensions BB & SBa Continued**

Bore Ø	Rod No.	K	LR	LS	MR	MS max	Y	+ Stroke						
								LB	P	XC	XO <sup>5</sup>	XV	ZC	
38.1 (1½")	1	10	14.3	23	15.9	25	49	127.0	75	161.9	–	–	177.8	
	59						171.5			182.5	234.5	187.4		
50.8 (2")	1	13	25.4	26	23.8	31	59	133.4	75	184.2	182.5	247.5	208.0	
	65						190.5			188.8	253.8	214.3		
63.5 (2½")	1	13	23.8	32	23.8	38	59	136.5	78	187.3	–	–	211.1	
	2						71			200.0	217.2	297.2	223.8	
	3						65			193.7	210.8	290.8	217.5	
82.6 (3¼")	1	16	31.8	41	30.2	50	68	158.8	90	219.1	–	–	249.3	
	2						79			228.6	240.6	337.6	258.8	
	3						76			225.4	237.4	334.4	255.6	
101.6 (4")	1	16	44.5	50	41.3	61	76	168.3	97	247.7	–	–	289.0	
	2						86			257.2	266.2	386.2	298.4	
	3						79			250.8	259.9	379.9	292.1	
127.0 (5")	1	19	52.4	62	54.0	71	79	181.0	110	266.7	–	–	320.7	
	2						86			273.1	282.9	422.9	327.1	
	3						86			273.1	282.9	422.9	327.1	
	4						86			273.1	–	–	327.1	
152.4 (6")	1	22	58.7	78	60.3	93	86	212.7	130	308.0	–	–	368.3	
	2										358.3	538.3		–
	3										–	–		–
	4										358.3	538.3		–
177.8 (7")	1	24	69.9	–	73.0	–	92	241.3	146	349.3	–	–	422.3	
	2										–	–		–
	3										–	–		–
	4										–	–		–
203.2 (8")	1	27	82.6	–	79.4	–	94	266.7	168	381.0	–	–	460.4	
	2										–	–		–
	3										–	–		–
	5										–	–		–

All dimensions are in millimetres unless otherwise stated.

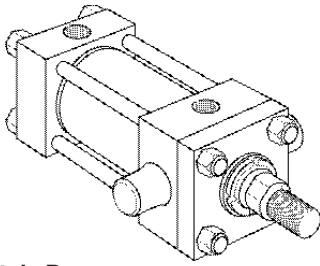

**Style D**  
Head Trunnion  
(NFPA Style MT1)

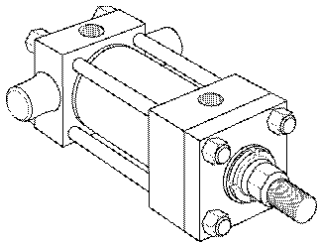
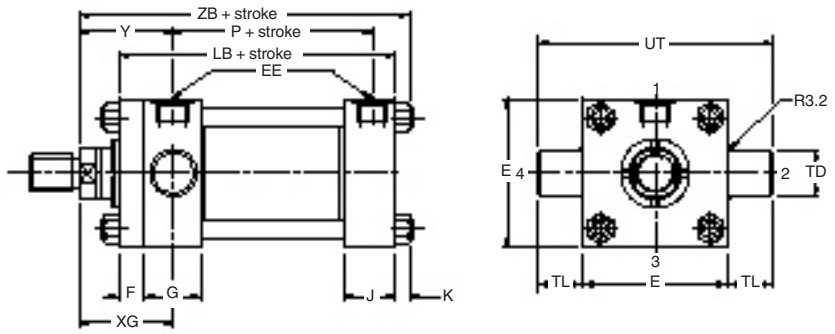

**Style DB**  
Cap Trunnion  
(NFPA Style MT2)

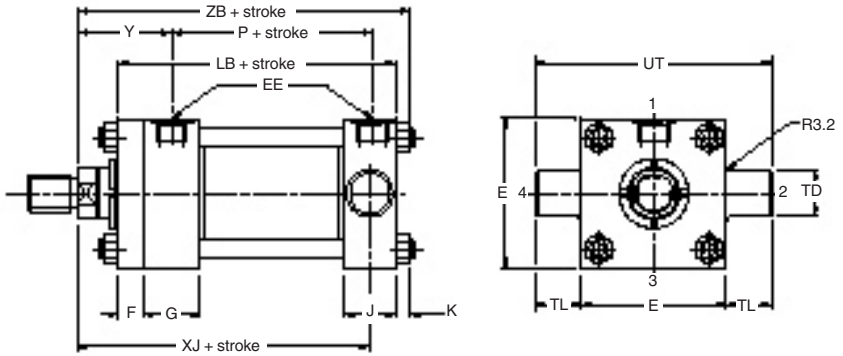

**Dimensions D, DB & DD** See also Dimensions, page 3 & Mounting Information, page 30

Bore Ø	Rod No.	BD	E	EE (BSPP)	F	G	J	K	TD <sup>+0.00</sup> <sub>-0.03</sub>	TL	TM	TY
38.1 (1½")	1	31.8	63.5	G½	9.5	44.5	38.1	10	25.40	25.4	76.2	69.9
	2											
50.8 (2")	1	38.1	76.2	G½	15.9	44.5	38.1	13	34.93	34.9	88.9	82.6
	2											
63.5 (2½")	1	38.1	88.9	G½	15.9	44.5	38.1	13	34.93	34.9	101.6	95.2
	2											
	3											
82.6 (3¼")	1	50.8	114.3	G¾	19.1	50.8	44.5	16	44.45	44.5	127.0	120.7
	2											
	3											
101.6 (4")	1	50.8	127.0	G¾	22.2	50.8	44.5	16	44.45	44.5	139.7	133.4
	2											
	3											
127.0 (5")	1	50.8	165.1	G¾	22.2	50.8	44.5	19	44.45	44.5	177.8	171.5
	2											
	3											
	4											
152.4 (6")	1	76.2	190.5	G1	25.4	57.2	57.2	22	50.8	50.8	215.9	196.9
	2											
	3											
	4											
177.8 (7")	1	76.2	215.9	G1¼	25.4	69.9	69.9	24	63.5	63.5	247.7	222.3
	2											
	3											
	4											
203.2 (8")	1	88.9	241.3	G1½	25.4	76.2	76.2	27	76.2	76.2	279.4	247.7
	2											
	3											
	4											
	5											

All dimensions are in millimetres unless otherwise stated.

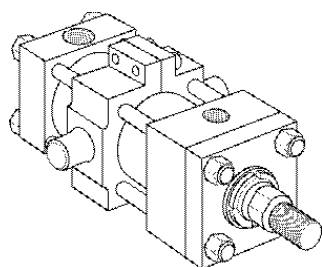

**Style DD**  
Intermediate Fixed Trunnion  
(NFFPA Style MT4)

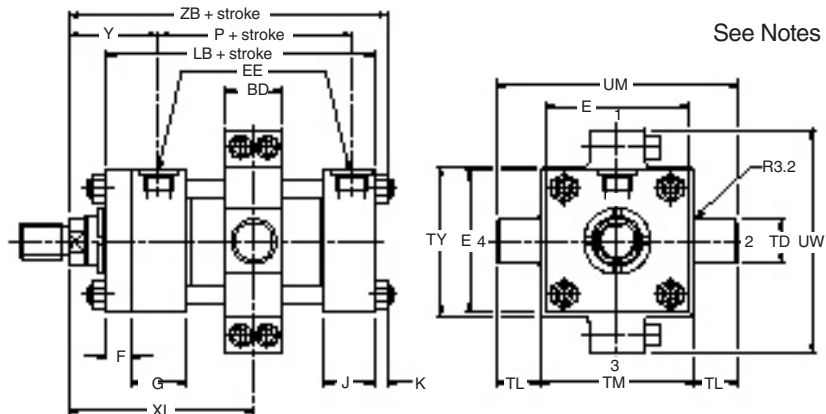

See Notes 1, 2, 3

**Notes**

- 1 Note the minimum strokes from the table below
- 2 XI dimension to be specified by customer, note minimum dimension
- 3 A one-piece trunnion is fitted to 38.1mm (1½"), 50.8mm (2") and 63.5mm (2½") bore cylinders

**Dimensions D, DB & DD Continued**

Bore Ø	Rod No.	UM	UT	UW <sup>3</sup>	XG	Min. <sup>2</sup> XI	Y	Style DD min stroke	+ Stroke			
									LB	P	XJ	ZB max
38.1 (1½")	1	127.0	114.3	-	47.6	85.7	49	0.0	127.0	75	123.8	152.4
	2				57.2	95.3	59				133.4	161.9
50.8 (2")	1	158.8	146.1	-	57.2	98.4	59	3.2	133.4	75	133.4	163.5
	2				63.5	104.8	65				139.7	169.9
63.5 (2½")	1	171.5	158.8	-	57.2	98.4	59	0.0	136.5	78	136.5	166.7
	2				69.9	111.1	71				149.2	179.4
	3				63.5	104.8	65				142.9	173.3
82.6 (3¼")	1	215.9	203.2	171.5	66.7	117.5	68	6.4	158.8	90	158.8	195.3
	2				76.2	127.0	79				168.3	204.8
	3				73.0	123.8	76				165.1	201.6
101.6 (4")	1	228.6	215.9	184.2	73.0	123.8	76	0.0	168.3	97	171.5	208.0
	2				82.6	133.4	86				181.0	217.5
	3				76.2	127.0	79				174.6	211.1
127.0 (5")	1	266.7	254.0	228.6	76.2	127.0	79	0.0	181.0	110	187.3	230.2
	2				82.6	133.4	86				193.7	236.5
	3				82.6	133.4	86				193.7	236.5
	4				82.6	133.4	86				193.7	236.5
152.4 (6")	1	317.5	292.1	260.4	85.7	152.4	86	3.2	212.7	130	212.7	266.7
	2											
	3											
	4											
177.8 (7")	1	374.7	342.9	292.1	92.1	165.1	92	0.0	241.3	146	238.1	298.5
	2											
	3											
	4											
203.2 (8")	1	431.8	393.7	323.9	95.3	177.8	94	0.0	266.7	168	260.4	325.4
	2											
	3											
	5											

All dimensions are in millimetres unless otherwise stated.

Head Flange Mountings 254.0 - 304.8mm bores 2H Series

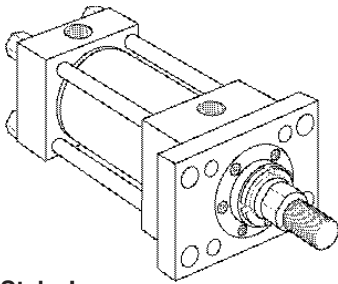

**Style J**  
Head Rectangular Flange  
(NFFA Style MF1)

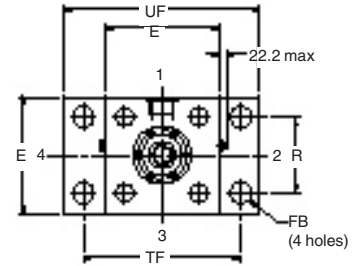
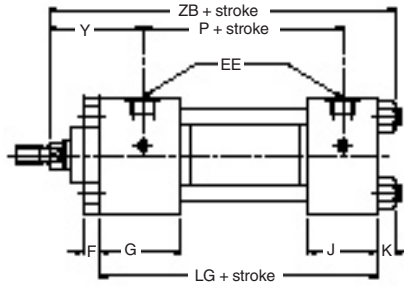

See Notes 1, 2, 3, 4

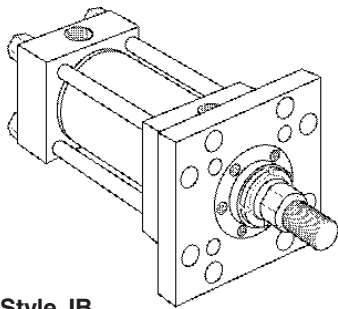

**Style JB**  
Head Square Flange  
(NFFA Style MF5)

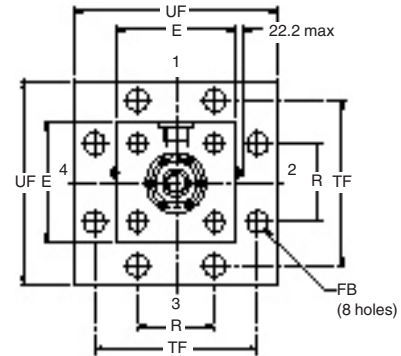
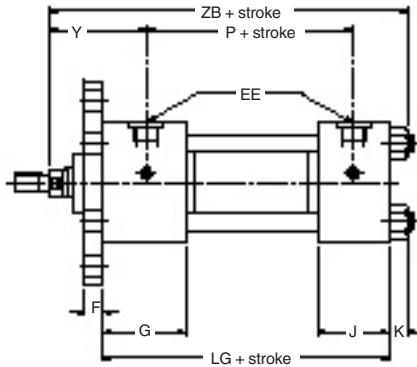

See Notes 1, 2, 4

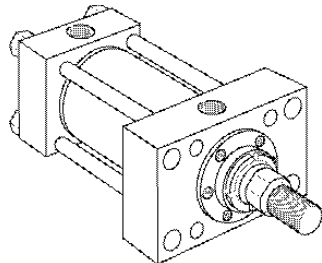

**Style JJ**  
Rectangular Head  
(NFFA Style ME5)

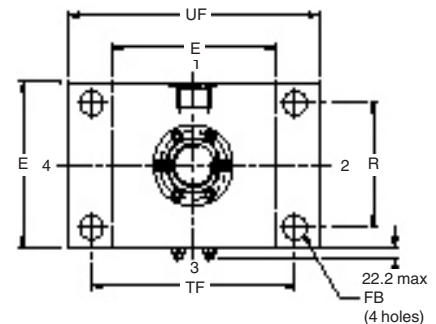
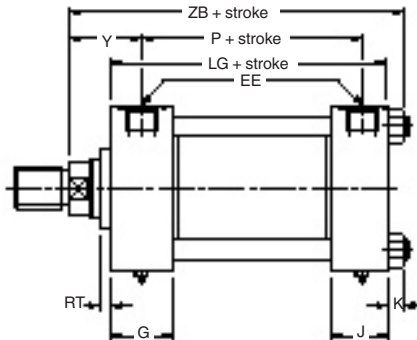

See Notes 1, 2, 4

**Dimensions J, JB & JJ** See also Dimensions, page 42 & Mounting Information, page 30

Bore Ø	Rod No.	E	EE <sup>4</sup> (BSPP)	F	FB	G	J	K	R	RT	TF	UF	Y	+ Stroke		
														LG	P	ZB max
254.0 (10")	1	320.7	G2	42.9	46.0	93.7	93.7	39	244.3	25.4	403.2	482.6	120.7	308.0	215.9	422.3
	2															
304.8 (12")	1	377.8	G2½	49.2	52.4	112.7	112.7	See note 2	290.8	33.3	469.9	558.8	136.5	368.3	257.2	449.3
	2															

**Notes**

- 1 The dimensional drawings show 254mm (10") bore models fitted with four tie rods, but can also be used to determine dimensions for 304.8mm (12") bore models fitted with 16 tie rods – see page 7
- 2 Tie rod nuts are flush with cap on 304.8mm (12") cylinders
- 3 For maximum pressure ratings, see page 36
- 4 Flange ports to ISO 6162 are also available – see page 37

All dimensions are in millimetres unless otherwise stated.



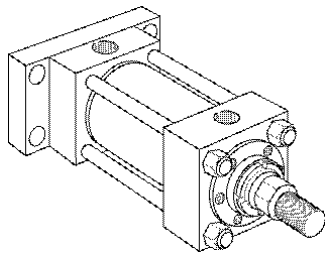

**Style H**  
Cap Rectangular Flange  
(NFA Style MF2)

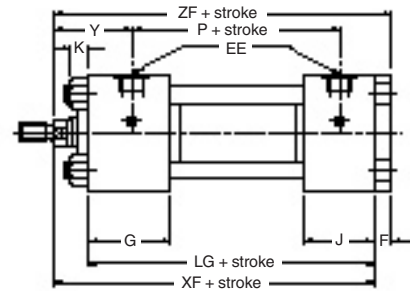
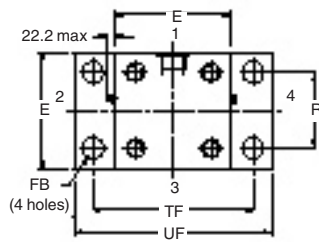

See Notes 1, 2, 3, 4

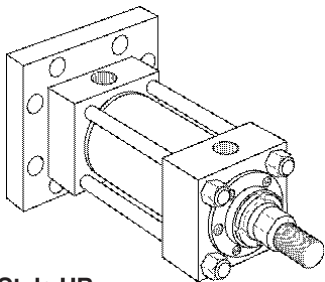

**Style HB**  
Cap Square Flange  
(NFA Style MF6)

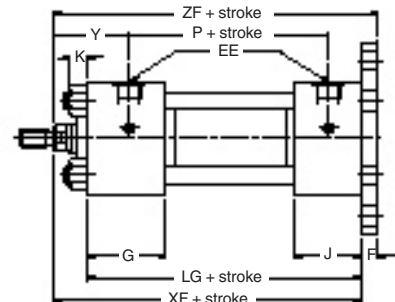
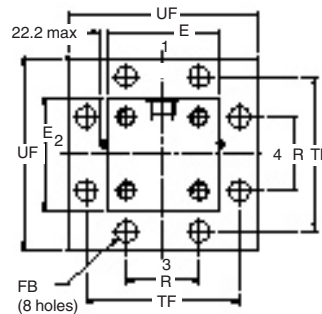

See Notes 1, 2, 4

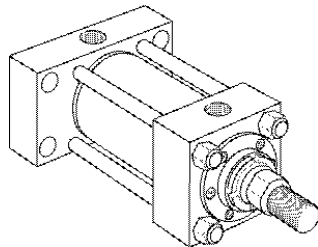

**Style HH**  
Rectangular Cap  
(NFA Style ME6)

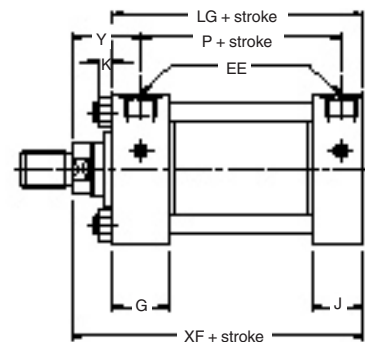
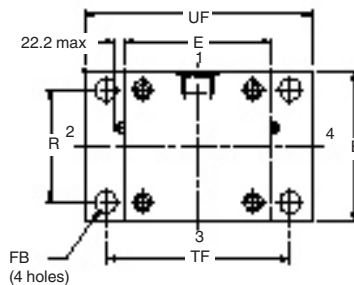

See Notes 1, 2, 4

**Dimensions H, HB & HH** See also Dimensions, page 42 & Mounting Information, page 30

Bore Ø	Rod No.	E	EE <sup>4</sup> (BSPP)	F	FB	G	J	K	R	TF	UF	Y	+ Stroke			
													LG	P	XF	ZF
254.0 (10")	1	320.7	G2	42.9	46.0	93.7	93.7	39	244.3	403.2	482.6	120.7	308.0	215.9	382.6	425.5
	2															
304.8 (12")	1	377.8	G2½	49.2	52.4	112.7	112.7	See note 2	290.8	469.9	558.8	136.5	368.3	257.2	449.3	498.5
	2															

**Notes**

- 1 The dimensional drawings show 254mm (10") bore models fitted with four tie rods, but can also be used to determine dimensions for 304.8mm (12") bore models fitted with 16 tie rods – see page 7
- 2 Tie rod nuts are flush with head on 304.8mm (12") cylinders
- 3 For maximum pressure ratings, see page 36
- 4 Flange ports to ISO 6162 are also available – see page 37

All dimensions are in millimetres unless otherwise stated.

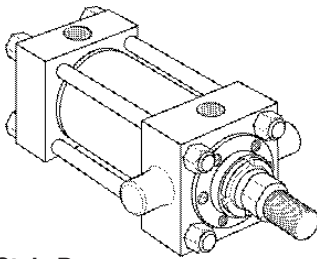

**Style D**  
 Head Trunnion  
 (NFFPA Style MT1)

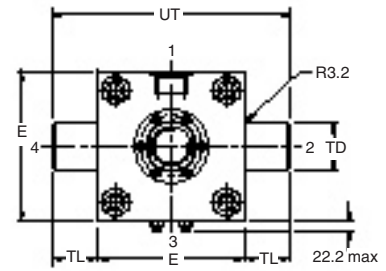
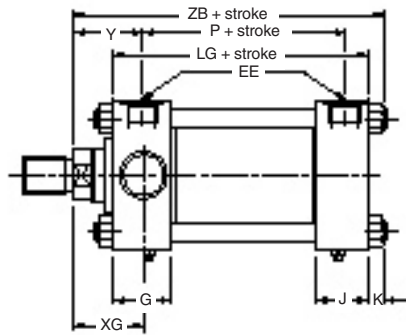

4

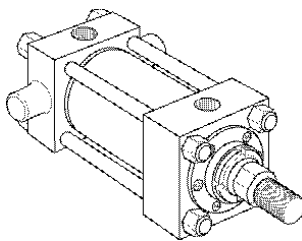

**Style DB**  
 Cap Trunnion  
 (NFFPA Style MT2)

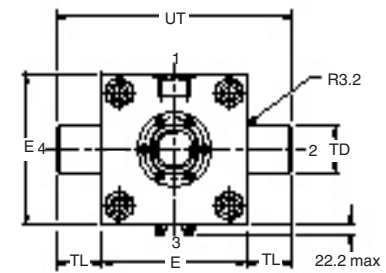
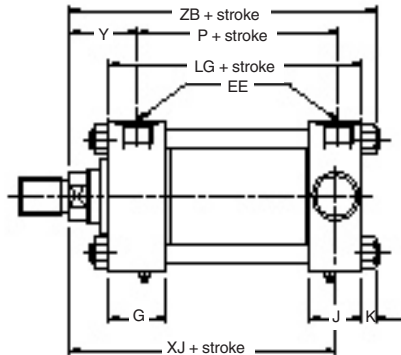

1, 2, 4

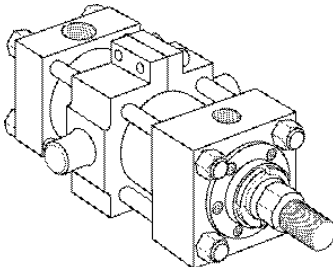

**Style DD**  
 Intermediate Fixed Trunnion  
 (NFFPA Style MT4)

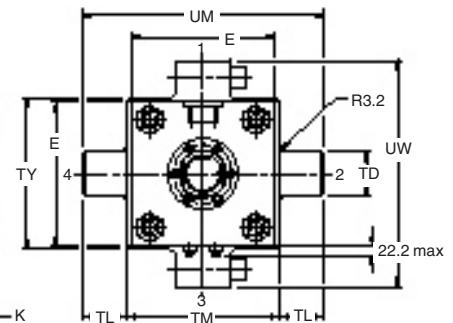
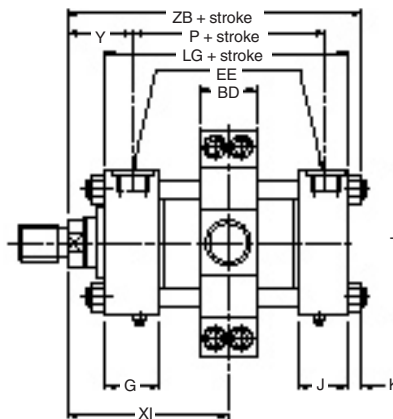

4

**Dimensions D, DB, & DD** See also Dimensions, page 42 & Mounting Information, page 30

Bore Ø	Rod No.	BD	E	EE <sup>4</sup> (BSPP)	G & J	K	TD <sup>+0.000</sup> <sub>-0.025</sub>	TL	TM	TY	UM	UT	UW	Min. <sup>3</sup> XI	XG & Y	+ Stroke			
																LG	P	XJ	ZB max
254.0 (10")	1	114.3	320.7	G2	93.7	39	88.9	88.9	355.6	330.2	533.4	498.5	444.5	225.4	120.7	308.0	215.9	336.6	421.6
	2																		
304.8 (12")	1	139.7	377.8	G2½	112.7	See note 2	101.6	101.6	419.1	393.7	622.3	581.0	527.1	263.5	136.5	368.3	257.2	393.7	449.3
	2																		

**Notes**

- 1 The dimensional drawings show 254mm (10") bore models fitted with four tie rods, but can also be used to determine dimensions for 304.8mm (12") bore models fitted with 16 tie rods – see page 7
- 2 Tie rod nuts are flush with head and cap on 304.8mm (12") cylinders
- 3 Dimension XI to be specified by customer
- 4 Flange ports to ISO 6162 are also available – see page 37

All dimensions are in millimetres unless otherwise stated.



See Notes 1, 2, 3, 4

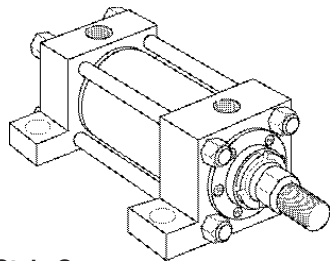

**Style C**  
Side Lug  
(NFFA Style MS2)

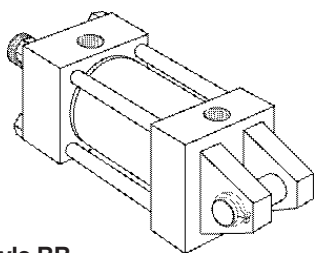
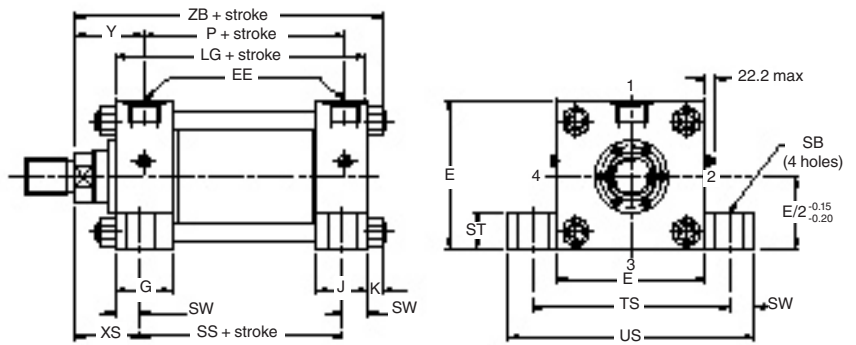

**Style BB**  
Cap Fixed Clevis  
(NFFA Style MP1)

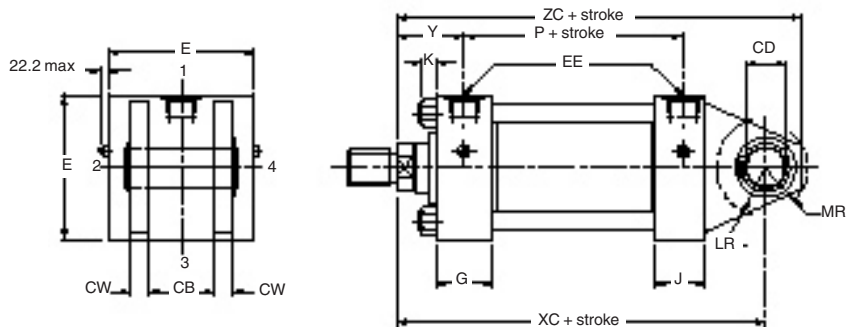

See Notes 1, 2, 4, 5

**Dimensions C & BB** See also Dimensions, page 42 & Mounting Information, page 30

Bore Ø	Rod No.	CB	CD <sup>+0.00</sup> <sub>-0.08</sub>	CW	E	EE <sup>4</sup> (BSPP)	G & J	K	LR	MR	SB	ST	SW	TS	US	XS	Y	+ Stroke						
																		LG	P	SS	XC	ZB max	ZC	
254.0 (10")	1	101.6	88.93	50.8	320.7	G2	93.7	39	98.4	90.0	39	57.2	41.3	403.2	485.8	115.9	120.7	127.0	308.0	215.9	225.4	483.4	421.6	573.1
	2																							
304.8 (12")	1	114.3	101.63	57.2	377.8	G2½	112.7	See note 2	111.1	111.1	39	76.2	50.8	479.4	581.0	131.8	136.5	142.9	368.3	257.2	266.7	563.6	449.3	665.2
	2																							

**Notes**

- 1 The dimensional drawings show 254mm (10") bore models fitted with four tie rods, but can also be used to determine dimensions for 304.8mm (12") bore models fitted with 16 tie rods – see page 7
- 2 Tie rod nuts are flush with head and cap on 304.8mm (12") cylinders
- 3 Style C cylinders can be supplied with the cylinder ports arranged for mounting and sealing to a manifold surface – see page 31
- 4 Flange ports to ISO 6162 are also available – see page 37
- 5 Supplied complete with pivot pin

All dimensions are in millimetres unless otherwise stated.

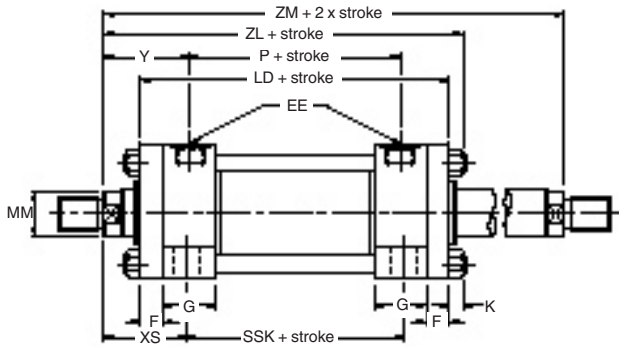

**Double Rod Cylinder** Available with Styles TB, TD, J, JB, JJ, C, F, D, DD, and G  
**38.1 to 203.2mm Bores**

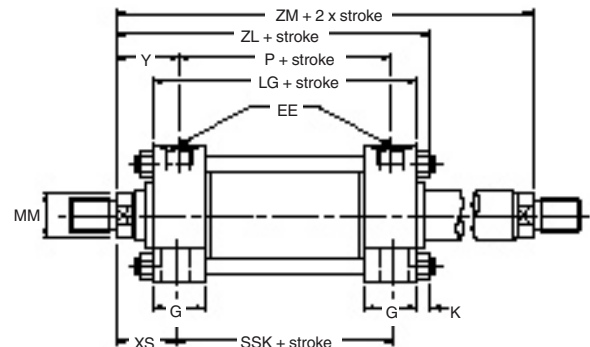

**Double Rod Cylinders** Available with Styles J, JB, JJ, C, D, and DD  
**254 and 304.8mm Bores**

**Mounting Styles and Codes**

Double rod cylinders are denoted by a 'K' in the model code, shown on page 43.

**Dimensions**

To obtain dimensional information for double rod cylinders, first select the desired mounting style by referring to the corresponding single rod models shown on the preceding pages. Dimensions for the appropriate single rod model should be supplemented by those from the table opposite to provide a full set of dimensions.

**Rod Strength**

Double rod cylinders employ two separate piston rods, with one screwed into the end of the other within the piston rod assembly. As a result, one piston rod is stronger than the other. The stronger rod is identified by the letter 'K' stamped on its end, and its pressure limitations with a 4:1 design factor are identical to those shown in the table on page 36 for the equivalent single rod assembly. The weaker rod should always be used for the lighter duty. Pressure limitations for the weaker rod in pull applications at a 4:1 design factor are also identical to those on page 36, except for the bore sizes shown in the table below.

Bore Ø	Rod Diameter	4 : 1 Design Factor (bar)
63.5 (2½")	25.4 (1")	95
82.6 (3¼")	34.9 (1¾")	115

**Combination Rods**

Double rod cylinders with stronger and weaker rods of differing rod sizes are also available. Please contact the factory for details.

**Cushioning**

Double rod cylinders can be supplied with cushions at either or both ends. Cushioning requirements should be specified by inserting a 'C' in the ordering code – see page 43. Double rod cylinders that require cushioning are supplied with floating cushion sleeves as standard.

Bore Ø	Rod No.	MM Rod Diameter	+ Stroke					+ 2x Stroke	
			LD <sup>1</sup> LG <sup>2</sup>	ZL	SEK <sup>3</sup>	SNK <sup>4</sup>	SSK <sup>5</sup>	ZM	
38.1 (1½")	1	15.9 (5/8")							
	2	25.4 (1")							
50.8 (2")	1	25.4 (1")							
	2	34.9 (1¾")							
63.5 (2½")	1	25.4 (1")							
	2	44.5 (1¾")							
	3	34.9 (1¾")							
82.6 (3¼")	1	34.9 (1¾")							
	2	50.8 (2")							
	3	44.5 (1¾")							
101.6 (4")	1	44.5 (1¾")							
	2	63.5 (2½")							
	3	50.8 (2")							
127.0 (5")	1	50.8 (2")							
	2	88.9 (3½")							
	3	63.5 (2½")							
	4	76.2 (3")							
152.4 (6")	All	All							
177.8 (7")	All	All							
203.2 (8")	All	All							
254.0 (10")	1	127.0 (5")							
304.8 (12")	1	139.7 (5½")							

<sup>1</sup> Use LD dimensions for 38.1mm to 203.2mm (1½" to 8") bore sizes  
<sup>2</sup> Use LG dimensions for 254.0mm & 304.8mm (10" & 12") bore sizes  
<sup>3</sup> SEK dimensions apply to mounting style KG only  
<sup>4</sup> SNK dimensions apply to mounting style KF only  
<sup>5</sup> SSK dimensions apply to mounting style KC only

**Style 9 Rod Ends**

If a stroke of less than 25mm on bore sizes up to 82.6mm (3¼"), or a stroke of less than 100mm on bore sizes of 101.6mm (4") and over, is required, where Style 9 rod ends are required at both ends, please consult the factory.

All dimensions are in millimetres unless otherwise stated.



**Accessory Selection**

Accessories for the rod end of a cylinder are selected by reference to the rod end thread, shown on pages 3 and 42, while the same accessories, when used at the cap end, are selected by cylinder bore size. See tables of part numbers below and on the following pages.

**Pivot Pin Diameters**

To obtain the same diameter of pivot pin at the rod end and cap end of a style BB clevis-mounted cylinder fitted with a rod clevis or plain rod eye, a no. 1 rod should be specified.

Pivot pins of the same diameter can be obtained at each end of a style SBa cylinder fitted with a rod end spherical bearing by specifying a style 7 rod end and nos. 2, 3 or 4 rods, as indicated in the table on page 3.

**Rod and Cap End Accessories**

Accessories for the 2H cylinder comprise:

- Rod End** – rod clevis, eye bracket and pivot pin  
 – plain rod eye, clevis bracket and pivot pin  
 – rod eye with spherical bearing

- Cap End** – eye bracket for style BB mounting

**Rod Clevis, Eye Bracket and Pivot Pin**

Thread KK	Rod Clevis	Eye Bracket	Pivot Pin	Nominal Force kN	Mass kg
M10x1.5	50940G	69195	68368	18.3	0.7
M12x1.5	50941G	69195	68368	18.3	0.7
M20x1.5	50942G	96196	68369	46.8	2.3
M22x1.5	50943G	85361 <sup>1</sup>	68370	83.8	5.2
M26x1.5	50944G	85361 <sup>1</sup>	68370	91.0	5.1
M33x2	50945G	69198	68371	94.5	9.9
M39x2	50946G	85362 <sup>1</sup>	68372	203.3	19.5
M45x2	50947G	85363 <sup>1</sup>	68373	312.1	28.6
M48x2	50948G	85363 <sup>1</sup>	68373	312.1	28.5
M58x3	50949G	85364 <sup>1</sup>	68374	420.0	48.4
M64x2	50950G	85365 <sup>1</sup>	68375	420.0	54.9
M68x2	50951G	85365 <sup>1</sup>	68375	543.6	63.1
M76x2	50952G	73538	73545	256.0	104.8
M90x2	50953G	73539	73547	334.4	157.8
M100x2	50954G	73539	73547	334.4	156.6
M110x2	–	–	–	–	–

<sup>1</sup> Cylinder accessory dimensions conform to NFPA recommended standard, NFPA/T3.6.8.R1 - 1984

**Rod Eye With Spherical Bearing**

Thread KK	Part No.	Torque Load Nm	Mass kg
M16x1.5	145239	13	0.4
M20x1.5	145240	13	0.7
M27x2	145241	32	1.2
M33x2	145242	32	2.1
M42x2	145243	64	4.4
M48x2	145244	80	7.6
M64x2	145245	195	14.5

All dimensions are in millimetres unless otherwise stated.

**Load Capacity**

The various accessories on these pages have been load rated for your convenience. The load capacity in kN is the recommended maximum load for that accessory based on a 4:1 factor of safety in tension. (Pivot pin is rated in shear). Before specifying, compare the actual load or the pull force at maximum operating pressure of the cylinder with the load capacity of the accessory you plan to use. If the load or pull force of the cylinder exceeds the load capacity of the accessory, please consult the factory.

**Plain Rod Eye, Clevis Bracket and Pivot Pin**

Thread KK	Plain Rod Eye	Clevis Bracket	Pivot Pin	Nominal Force kN	Mass kg
M10x1.5	69089G	69205	68368	22.3	1.3
M12x1.5	69090G	69205	68368	25.4	1.3
M20x1.5	69091G	69206	68369	54.0	3.2
M22x1.5	69092G	69207	68370	58.0	6.6
M26x1.5	69093G	69207	68370	85.6	6.6
M33x2	69094G	69208	68371	149.4	12.7
M39x2	69095G	69209	68372	151.6	23.4
M45x2	69096G	69210	69215	147.2	41.1
M48x2	69097G	69210	69215	147.2	41.5
M58x3	69098G	69211	68374	155.6	51.2
M64x2	69099G	69212	68375	150.7	65.2
M68x2	69100G	69213	69216	164.6	69.5
M76x2	73536G	73542	73545	372.3	126.7
M90x2	73437G	73542	73545	372.3	124.0
M100x2	73438G	73543	82181	457.5	180.7
M110x2	73439G	73544	73547	483.4	173.5

**Cap End Eye Bracket for Style BB Cylinders**

Bore Ø	Eye Bracket Part No.	Nominal Force kN	Mass kg
38.1 (1½")	69195	18.3	0.4
50.8 (2")	69196	46.8	1.5
63.5 (2½")	69196	46.8	1.5
82.6 (3¼")	85361 <sup>1</sup>	91.0	3.4
101.6 (4")	69198	94.5	5.6
127.0 (5")	85362 <sup>1</sup>	220.6	11.1
152.4 (6")	85363 <sup>1</sup>	312.1	17.0
177.8 (7")	85364 <sup>1</sup>	420.0	27.4
203.2 (8")	85365 <sup>1</sup>	543.6	35.8
254.0 (10")	73538	256.0	55.6
304.8 (12")	73539	334.4	84.3

**Rod Clevis, Eye Bracket and Pivot Pin**

**Rod Clevis Dimensions**

Part No.	A	CB	CD <sup>+0.10</sup> / <sub>+0.05</sub>	CE	CW	ER	KK	Nominal Force kN	Mass kg
50940G	19.1	19.8	12.70	38.1	12.7	12.7	M10x1.5	18.9	0.2
50941G	19.1	19.8	12.70	38.1	12.7	12.7	M12x1.5	21.9	0.2
50942G	28.6	32.6	19.05	54.0	15.9	19.1	M20x1.5	49.9	0.6
50943G	41.3	38.9	25.40	74.6	19.1	25.4	M22x1.5	83.8	1.3
50944G	41.3	38.9	25.40	74.6	19.1	25.4	M26x1.5	96.7	1.3
50945G	50.8	51.6	34.93	95.3	25.4	34.9	M33x2	149.4	3.1
50946G	57.2	64.7	44.45	114.3	31.8	44.5	M39x2	203.3	6.0
50947G	76.2	64.7	50.80	139.7	31.8	50.8	M45x2	317.9	8.4
50948G	76.2	64.7	50.80	139.7	31.8	50.8	M48x2	341.6	8.3
50949G	88.9	77.4	63.50	165.1	38.1	63.5	M58x2	480.2	15.1
50950G	88.9	77.4	76.20	171.5	38.1	69.9	M64x2	535.1	19.0
50951G	88.9	77.4	76.20	171.5	38.1	69.9	M68x2	589.9	18.7
50952G	88.9	102.8	88.90	196.9	50.8	88.9	M76x2	1048.8	34.1
50953G	101.6	116.0	101.60	223.8	57.2	101.6	M90x2	1292.2	49.8
50954G	101.6	116.0	101.60	223.8	57.2	101.6	M100x2	1480.0	48.6

**Rod Clevis (Female Clevis)**

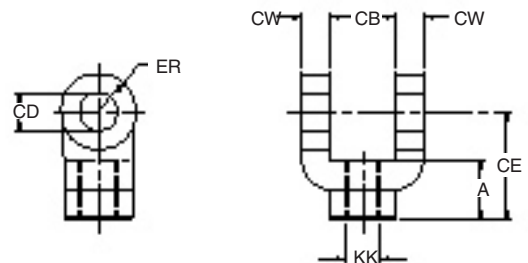

**Eye Bracket Dimensions**

Part No.	CB	CD <sup>+0.10</sup> / <sub>+0.05</sub>	DD	E	F	FL	LR	M	MR	R	Nominal Force kN	Mass kg
69195	19.1	12.70	10.3	63.5	9.5	28.6	19.1	12.7	14.3	41.4	18.3	0.4
69196	31.8	19.05	13.5	88.9	15.9	47.6	31.8	19.1	22.2	64.8	46.8	1.5
85361 <sup>1</sup>	38.1	25.40	16.7	114.3	22.2	60.3	38.1	25.4	31.8	82.6	91.0	3.4
69198	50.8	34.93	16.7	127.0	22.2	76.2	54.0	34.9	41.3	97.0	94.5	5.6
85362 <sup>1</sup>	63.5	44.45	23.0	165.1	28.6	85.7	57.2	44.5	54.0	125.7	220.6	11.1
85363 <sup>1</sup>	63.5	50.80	27.0	190.5	38.1	101.6	63.5	50.8	61.9	145.5	312.1	17.0
85364 <sup>1</sup>	76.2	63.50	30.2	215.9	44.5	120.6	76.2	63.5	76.2	167.1	420.0	27.4
85365 <sup>1</sup>	76.2	76.20	33.3	241.3	50.8	133.3	82.6	69.9	82.6	190.5	543.6	35.8
73538	101.6	88.90	46.0	320.7	42.9	114.5	101.6	88.9	95.3	244.3	256.0	55.6
73539	114.3	101.60	52.4	377.8	49.2	163.5	114.3	101.6	108.0	290.8	334.4	84.3

**Eye Bracket**

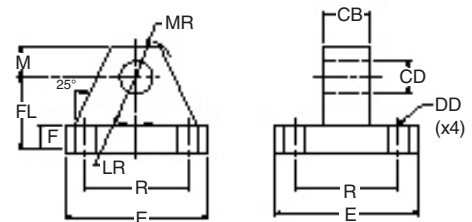

<sup>1</sup> Cylinder accessory dimensions conform to NFPA recommended standard, NFPA/T3.6.8.R1 - 1984

**Pivot Pin for Clevis Bracket & Eye Bracket**

Part No.	CD <sup>+0.00</sup> / <sub>-0.05</sub>	CL <sup>+0.0</sup> / <sub>-0.5</sub>	G	Nominal Force kN	Mass kg
68368	12.73	46.3	56	38.4	0.1
68369	19.08	65.4	75	86.1	0.2
68370	25.43	77.9	88	152.9	0.5
68371	34.95	103.4	115	289.8	1.2
68372	44.48	128.8	143	469.1	2.4
68373	50.83	129.7	145	612.7	3.2
69215	50.83	141.4	158	612.7	3.5
68374	63.53	155.1	171	957.4	5.9
68375	76.23	154.7	173	1378.7	8.6
69216	76.23	167.7	185	1378.7	9.2
73545	88.93	205.7	225	1876.8	15.2
82181	101.63	220.3	254	2522.9	22.4
73547	101.63	231.7	266.7	2522.9	23.5

**Pivot Pin for Clevis Bracket & Eye Bracket**



All dimensions are in millimetres unless otherwise stated.

**Plain Rod Eye, Clevis Bracket and Pivot Pin**

**Plain Rod Eye Dimensions**

Part No.	A min.	CA	CB	CD	ER	KK	Nominal Force kN	Mass kg
69089G	19.1	38.1	19.1	12.70	18.3	M10x1.5	22.3	0.2
69090G	19.1	38.1	19.1	12.70	18.3	M12x1.5	25.4	0.2
69091G	28.6	52.4	31.8	19.05	27.0	M20x1.5	54.0	0.5
69092G	28.6	60.3	38.1	25.40	36.5	M22x1.5	58.0	1.1
69093G	41.3	71.4	38.1	25.40	36.5	M26x1.5	96.8	1.1
69094G	50.8	87.3	50.8	34.93	50.0	M33x2	149.4	2.6
69095G	57.2	101.6	63.5	44.45	63.5	M39x2	200.6	5.1
69096G	57.2	111.1	63.5	50.80	72.2	M45x2	238.6	6.4
69097G	76.2	127.0	63.5	50.80	72.2	M48x2	334.4	6.8
69098G	88.9	147.6	76.2	63.50	90.5	M58x2	440.1	12.1
69099G	88.9	155.6	76.2	76.20	108.0	M64x2	490.5	16.0
69100G	92.1	165.1	88.9	76.20	108.0	M68x2	549.8	19.6
73536G	101.6	193.7	101.6	88.90	126.2	M76x2	719.3	31.1
73437G	127.0	193.7	101.6	88.90	126.2	M90x2	969.0	28.4
73438G	139.7	231.8	114.3	101.60	144.5	M100x2	1220.9	42.5
73439G	139.7	231.8	127.0	101.60	144.5	M110x2	1375.6	48.4

**Plain Rod Eye**

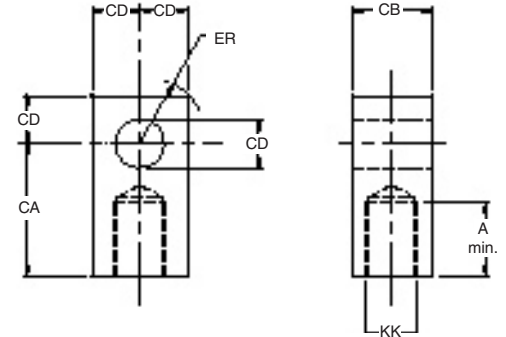

**Clevis Bracket Dimensions**

Part No.	CB	CD <sup>+0.10</sup> / <sub>+0.05</sub>	CW	DD	E	F	FL	LR	M	MR	R	Nominal Force kN	Mass kg
69205	19.8	12.70	12.7	10.3	88.9	12.7	38.1	19.1	12.7	15.9	64.8	32.6	1.0
69206	32.6	19.05	15.9	13.5	127.0	15.9	47.6	30.2	19.1	23.0	97.0	62.4	2.5
69207	38.9	25.40	19.1	16.7	165.1	19.1	57.2	38.1	25.4	31.8	125.7	85.6	5.0
69208	51.6	34.93	25.4	16.7	190.5	22.2	76.2	50.8	34.9	42.1	145.5	164.6	8.8
69209	64.7	44.45	31.8	23.0	241.3	22.2	92.1	69.9	44.5	56.4	190.5	151.6	15.9
69210	64.7	50.80	38.1	27.0	323.9	25.4	108.0	81.0	57.2	70.6	238.8	147.2	31.2
69211	77.4	63.50	38.1	30.2	323.9	25.4	114.3	88.9	63.5	79.4	238.8	155.6	33.2
69212	77.4	76.20	38.1	33.3	323.9	25.4	152.4	108.0	76.2	91.3	238.8	150.7	40.7
69213	90.1	76.20	38.1	33.3	323.9	25.4	152.4	108.0	76.2	91.3	238.8	164.6	40.7
73542	102.8	88.90	50.8	46.0	393.7	42.9	169.9	127.0	88.9	104.8	304.8	372.3	80.4
73543	116.0	101.60	50.8	52.4	444.5	49.2	195.3	146.1	101.6	123.8	349.3	457.5	115.8
73544	128.2	101.60	50.8	52.4	444.5	49.2	195.3	146.1	101.6	123.8	349.3	483.4	101.6

**Clevis Bracket**

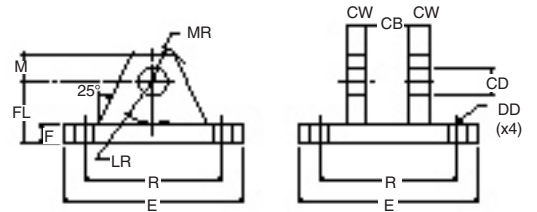

**Rod Eye with Spherical Bearing – ISO 6982**

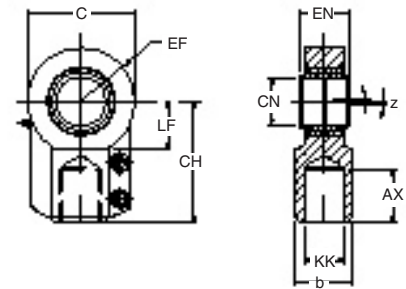

**Rod Eye with Spherical Bearing Dimensions - ISO 6982**

Part No.	AX min.	b	C max.	CH	CN H7	EF max.	EN h12	KK (Style 7)	LF	Z	Clamp screw torque (Nm)	Mass kg
145239	23	25	50	52	20	25	20	M16x1.5	22	4°	13	0.4
145240	29	30	62	65	25	32	25	M20x1.5	27		13	0.7
145241	37	38	76	80	32	40	32	M27x2	32		32	1.2
145242	46	47	97	97	40	50	40	M33x2	41		32	2.1
145243	57	58	118	120	50	63	50	M42x2	50		64	4.4
145244	64	70	142	140	63	71	63	M48x2	62		80	7.6
145245	86	90	180	180	80	90	80	M64x3	78		195	

All dimensions are in millimetres unless otherwise stated.

### Mounting Styles

General guidance for the selection of mounting styles is given on page 9. The notes which follow provide information for use in specific applications and should be read in conjunction with the information given on page 9.

### Extended Tie Rods

The standard tie rod extension for cylinders with mounting styles TB, TC and TD is shown as BB in dimension tables. Longer or shorter extensions can be supplied.

Cylinders with extended tie rod mountings TB and TC are supplied with an additional set of mounting nuts of the appropriate grade for securing the cylinder to the machine member. For style TD, tie rods extended both ends, two additional sets of mounting nuts are supplied.

Cylinders may be ordered with extended tie rods in addition to another mounting style. The extended tie rods may then be used for mounting other systems or machine components.

### Flange Mounted Cylinders

The diameter of the rod gland extension (B) at the head end can be used as a pilot to locate the cylinders in relation to the machine. After alignment has been obtained, the flanges may be drilled for pins or dowels to prevent shifting.

### Pivot Mountings

Pivot pins are supplied with style BB cap fixed clevis mounted cylinders. Pivot pins are not supplied with the spherical bearing mounting, style SBa, as the pin length will be determined by the customer's equipment.

### Spherical Bearing

The life of the spherical bearings is influenced by many factors such as specific load, direction of load, angle of oscillation, and type and frequency of lubrication. The bearings are designed to give an acceptable life under normal operating conditions and, if unusual operating conditions exist, you should consult the factory. The maximum pressure rating for spherical bearing cylinders is 160 bar.

### Spherical Bearing Mountings

Where a spherical bearing mounting, style SBa, is specified for the cylinder, a rod eye with spherical bearing should be used at the rod end. A Style 7 rod end should be specified if the same diameter of pivot pin is required at both ends of the cylinder.

### Trunnion Mounted Cylinders

Trunnions require lubricated pillow blocks with minimum bearing clearances. Blocks should be aligned and mounted to eliminate bending moments on the trunnion pins. Self-aligning mounts must not be used to support the trunnions as bending forces can be set up.

An intermediate fixed trunnion mounting can be positioned to balance the weight of the cylinder, or it can be located at any point between the head or cap to suit the application. The position of the trunnion is fixed during manufacture and its location must be specified at the time of order.

### Foot Mounted Cylinders

Foot mounted cylinders should not be pinned or keyed at both ends. Changes in temperature and pressure under normal operating conditions cause the cylinder to increase (or decrease) from its installed length and it therefore must be free to expand and contract. It must not be pinned or keyed at both ends as advantages of cylinder elasticity in absorbing high shock loads would be lost.

### Foot Mountings and Thrust Keys

The turning moment which results from the application of force by a foot mounted cylinder must be resisted by secure mounting and effective guidance of the load. A thrust key modification is recommended to provide positive cylinder location.

Thrust key mountings eliminate the need for fitted bolts or external keys on Styles C, F and G side mounted cylinders. The gland retainer plate is extended below the nominal mounting surface to fit into a keyway milled into the mounting surface of the machine member. See 'Mounting Modifications' in the order code, page 43.

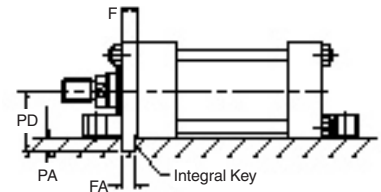

Bore Ø	F Nom.	FA +0.0 -0.075	PA +0.0 -0.2	PD
38.1 (1½")	9.5	8	4.9	36.5
50.8 (2")	15.9	14	8.0	46.0
63.5 (2½")	15.9	14	8.1	52.4
82.6 (3¼")	19.1	18	9.7	66.7
101.6 (4")	22.2	22	11.2	74.6
127.0 (5")	22.2	22	11.2	93.7
152.4 (6")	25.4	25	12.7	108.0
177.8 (7")	25.4	25	12.7	120.7
203.2 (8")	25.4	25	12.7	133.4

### Tie Rod Supports

To increase the resistance to buckling of long stroke cylinders, tie rod supports may be fitted. These move the tie rods radially outwards and allow longer than normal strokes to be used without the need for an additional mounting.

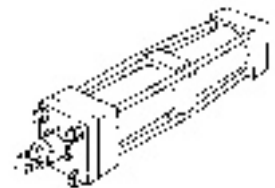

Bore Ø	Stroke (metres)												Number of supports req'd.
	0.9	1.2	1.5	1.8	2.1	2.4	2.7	3.0	3.3	3.6	3.9	4.2	
38.1	-	-	1	1	1	2	2	2	3	3	3	4	
50.8	-	-	-	1	1	1	1	2	2	2	2	3	
63.5	-	-	-	-	-	1	1	1	1	1	2	2	
82.6	-	-	-	-	-	-	-	1	1	1	1	1	
101.6	-	-	-	-	-	-	-	-	-	1	1	1	

Bore sizes above 101.6mm (4") do not require tie rod supports.

All dimensions are in millimetres unless otherwise stated.

**Manifold Ports**

Side mounted cylinders (Style C) can be supplied with the cylinder ports arranged for mounting and sealing to a manifold surface. The ports are drilled and counterbored for O-ring seals which are provided. With these specifications, the mounting is designated Style CM. Please consult the factory.

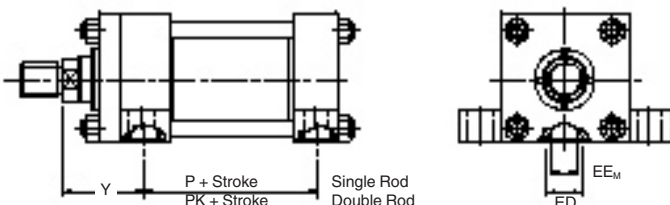

**Stroke Tolerances**

Stroke length tolerances are required due to the build-up of tolerances of piston, head, cap and cylinder body. Standard production stroke tolerances are -0.4 to +0.8mm on all bore sizes and stroke lengths. For closer tolerances, please specify the required tolerance plus the operating temperature and pressure. Stroke tolerances of less than 0.4mm are generally impracticable due to the elasticity of cylinders and, in these cases, the use of a stroke limiter should be considered – see page 39.

**Mounting Bolts**

Parker recommends that mounting bolts with a minimum strength of ISO 898/1 grade 10.9 should be used for fixing cylinders to the machine or base. This recommendation is of particular importance where bolts are placed in tension or subjected to shear forces. Mounting bolts should be torque loaded to their manufacturer's recommended figures.

Bore Ø	Rod No.	Y ±0.8	P ±0.8	PK ±0.8	EE <sub>M</sub>	ED	Parker O-ring No.
38.1 (1½")	1	50.8	73.0	73.0	19.1	28.6	2-212
	2	60.3					
50.8 (2")	1	60.3	73.0	73.0	19.1	28.6	2-212
	2	66.7					
63.5 (2½")	1	60.3	76.2	76.2	19.1	28.6	2-212
	2	73.0					
	3	66.7					
82.6 (3¼")	1	69.9	88.9	88.9	25.4	34.9	2-216
	2	79.4					
	3	76.2					
101.6 (4")	1	72.2	101.6	103.2	25.4	34.9	2-216
	2	81.8					
	3	75.4					
127.0 (5")	1	79.4	108.0	108.0	25.4	34.9	2-216
	2	85.7					
	3	85.7					
	4	85.7					
152.4 (6")	All	88.9	130.2	123.8	31.8	41.3	2-220
177.8 (7")	All	96.8	149.2	136.5	38.1	47.6	2-223
203.2 (8")	All	100.0	168.3	155.6	38.1	47.6	2-223
254.0 (10")	1	120.7	215.9	215.9	50.8	60.3	010404-0224
	2	127.0					
304.8 (12")	1	136.5	257.2	257.2	63.5	73.0	010404-0256
	2	142.9					

**Tie Rod Nuts**

Tie rod mounting nuts, with lubricated threads, should be to a minimum strength of ISO 898/2 grade 10, torque loaded to the figures shown.

Bore Ø	Tie Rod Nut Torque	
	Nm min-max	
38.1 (1½")	25-27	
50.8 (2")	60-65	
63.5 (2½")	160-165	
82.6 (3¼")	175-180	
101.6 (4")	420-425	
127.0 (5")	715-735	
152.4 (6")	1080-1100	
177.8 (7")	1560-1580	
203.2 (8")	3390-3410	
254.0 (10")	715-735	
304.8 (12")		

All dimensions are in millimetres unless otherwise stated.

**Calculation of Cylinder Diameter**

Given that the force and operating pressure of the system are known, and that a piston rod size has been estimated taking account of whether the rod is in tension (pull) or compression (push), then the cylinder bore can be selected.

If the piston rod is in compression, use the 'Push Force' table below, as follows:

1. Identify the operating pressure closest to that required.
2. In the same column, identify the force required to move the load (always rounding up).
3. In the same row, look along to the cylinder bore required.

If the cylinder envelope dimensions are too large for the application, increase the operating pressure, if possible, and repeat the exercise.

**Push Force**

Bore Ø	Piston Area mm <sup>2</sup>	Cylinder Push Force in kN						Displacement per 10mm stroke Litres
		5 bar	10 bar	25 bar	70 bar	100 bar	210 bar	
38.1 (1½")	1140	0.6	1.1	2.9	8.0	11.4	24.0	0.0114
50.8 (2")	2020	1.0	2.0	5.0	14.1	20.2	42.5	0.0202
63.5 (2½")	3170	1.6	3.2	7.9	22.2	31.7	66.6	0.0317
82.6 (3¼")	5360	2.7	5.4	13.4	37.5	53.5	113	0.0535
101.6 (4")	8110	4.0	8.1	20.3	56.8	81.1	170	0.0811
127.0 (5")	12670	6.4	12.7	31.6	88.5	126	266	0.1267
152.4 (6")	18240	9.1	18.3	45.5	127	182	383	0.1827
177.8 (7")	24830	12.4	24.9	62.2	174	248	523	0.2486
203.2 (8")	32430	16.2	32.5	81.1	227	324	682	0.3246
254.0 (10")	50670	25.4	50.6	127	354	506	1065	0.5073
304.8 (12")	72970	36.5	73.0	182	510	730	1532	0.7294

If the piston rod is in tension, use the 'Deduction for Pull Force' table. The procedure is the same but, due to the reduced area caused by the piston rod, the force available on the 'pull' stroke will be smaller. To determine the pull force:

1. Follow the procedure for 'push' applications as described above.
2. Using the 'pull' table, identify the force indicated according to the rod and pressure selected.
3. Deduct this from the original 'push' force. The resultant is the net force available to move the load.

If this force is not large enough, go through the process again but increase the system operating pressure or cylinder diameter if possible. If in doubt, our design engineers will be pleased to assist.

**Deduction for Pull Force**

Piston Rod Ø	Piston Rod Area mm <sup>2</sup>	Piston Rod Force in kN						Displacement per 10mm stroke Litres
		5 bar	10 bar	25 bar	70 bar	100 bar	210 bar	
15.9 (5/8")	200	0.1	0.2	0.5	1.4	2.0	4.2	0.0020
25.4 (1")	500	0.3	0.5	1.3	3.5	5.0	10.5	0.0050
34.9 (1 3/8")	960	0.5	1.0	2.4	6.8	9.6	20.2	0.0097
44.5 (1 3/4")	1560	0.8	1.6	3.9	10.9	15.6	32.8	0.0156
50.8 (2")	2020	1.0	2.0	5.0	14.1	20.2	42.5	0.0202
63.5 (2 1/2")	3170	1.6	3.2	7.9	22.2	31.7	66.6	0.0317
76.2 (3")	4560	2.3	4.6	11.4	32.0	45.6	95.8	0.0456
88.9 (3 1/2")	6210	3.1	6.2	15.5	43.4	62.0	130	0.0621
101.6 (4")	8110	4.0	8.1	20.3	56.8	81.1	171	0.0811
127.0 (5")	12670	6.4	12.7	31.6	88.7	127	266	0.1267
139.7 (5 1/2")	15330	7.7	15.3	38.4	107	153	322	0.1523
177.8 (7")	24830	12.4	24.9	62.2	174	249	523	0.2486
215.8 (8 1/2")	36610	18.3	36.6	91.5	257	366	769	0.3663

All dimensions are in millimetres unless otherwise stated.



**Piston Rod Size Selection**

The selection of a piston rod for thrust (push) conditions requires the following steps to be carried out:

1. Determine the type of cylinder mounting style and rod end connection to be used. Consult the Stroke Factor table on page 34 and determine which factor corresponds to the application.
2. Using the appropriate stroke factor from page 34, determine the 'basic length' from the equation:  
  

$$\text{Basic Length} = \text{Net Stroke} \times \text{Stroke Factor}$$

(The graph is prepared for standard rod extensions beyond the face of the gland retainers. For rod extensions greater than standard, add the increases to the net stroke to arrive at the 'basic length'.)
3. Calculate the load imposed for the thrust application by multiplying the full bore area of the cylinder by the system pressure, or by referring to the Push and Pull Force charts on page 32.
4. Using the graph below, look along the values of 'basic length' and 'thrust' as found in 2 and 3 above, and note the point of intersection.

**Note:** When considering the use of long stroke cylinders, the piston rod should be of sufficient diameter to provide the necessary column strength.

The correct piston rod size is read from the diagonally curved line labelled 'Rod Diameter' above the point of intersection.

**Stop Tubes**

Stop tubes prevent the cylinder from completing its full stroke, to provide a spread between the piston and the rod bearing at full extension. Note that stop tube requirements differ for fixed and pivot mounted cylinders. The required length of stop tube, where necessary, is read from the vertical columns on the right of the graph by following the horizontal band within which the point of intersection lies. If the required length of stop tube is in the region labelled 'consult factory', please supply the following:

1. Cylinder mounting style.
2. Rod end connection and method of guiding load.
3. Bore required, stroke, length of rod extension (dimension W or WF - dimension V - see pages 3 and 42) if greater than standard.
4. Mounting position of cylinder. (Note if at an angle or vertical, and specify the direction of the piston rod.)
5. Operating pressure of cylinder, if limited to less than the standard pressure for the cylinder selected.

For accurate sizing, please refer to the European cylinder inPHorm selection program (1260/1-Eur). When specifying a cylinder with a stop tube, please insert an S (Special) and the net stroke of the cylinder in the order code and state the length of the stop tube. Note that net stroke is equal to the gross stroke of the cylinder less the length of the stop tube. The gross stroke determines the envelope dimensions of the cylinder.

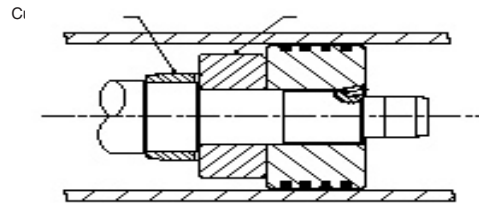

**Piston Rod Selection Chart**

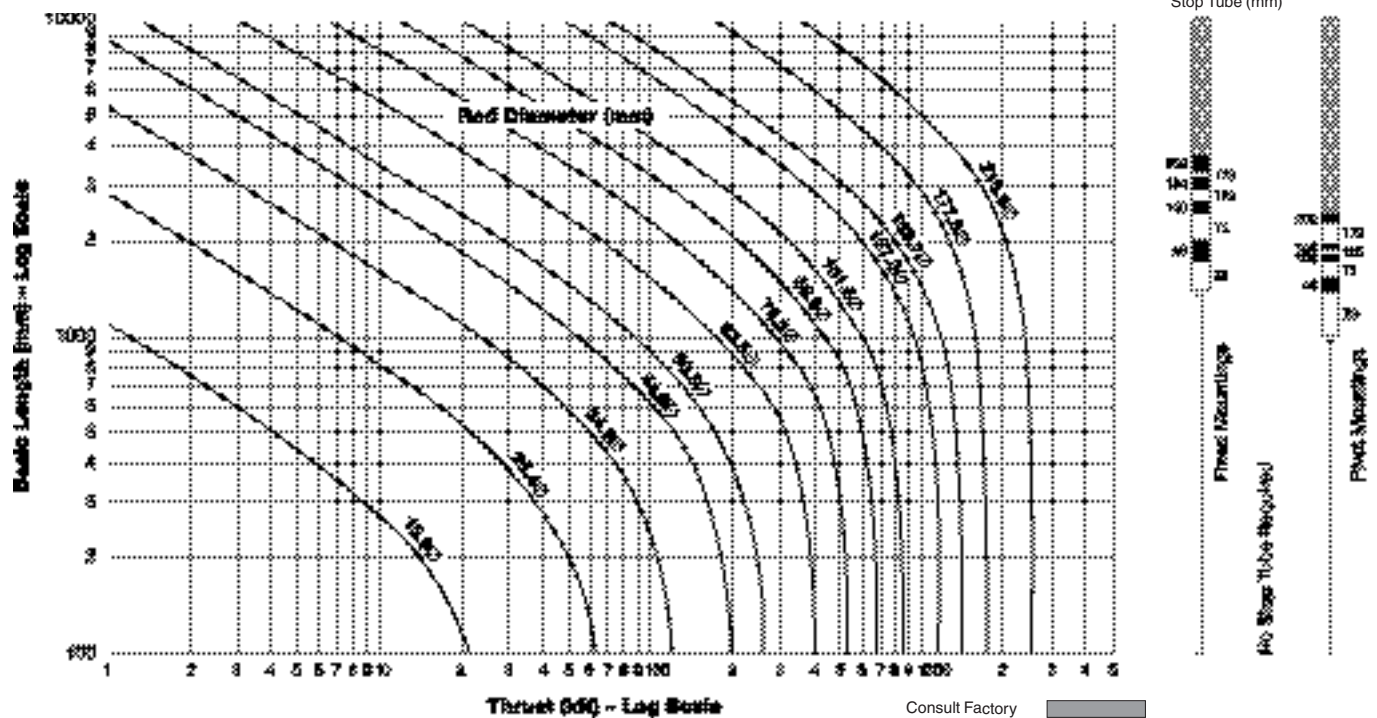

**Stroke Factors**

The stroke factors which follow are used in the calculation of cylinder 'basic length' – see Piston Rod Size Selection, page 33.

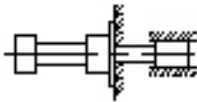
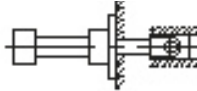
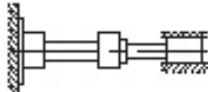
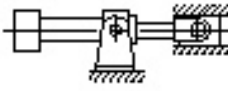
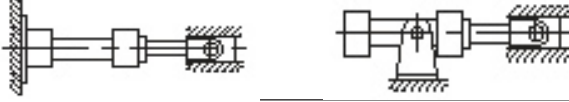
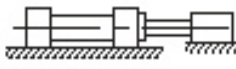
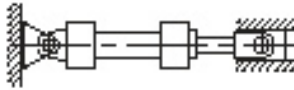
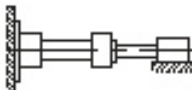
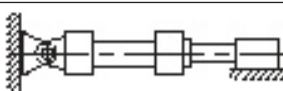
Rod End Connection	Mounting Style	Type of mounting	Stroke Factor
Fixed and rigidly Guided	TB, TD, J, JB JJ, C, F, G		0.5
Pivoted and rigidly Guided	TB, TD, J, JB JJ, C, F, G		0.7
Fixed and rigidly Guided	TC, H, HB, HH		1.0
Pivoted and rigidly Guided	D		1.0
Pivoted and rigidly Guided	TC, H, HB, HH, DD		1.5
Supported but not Rigidly Guided	TB, TD, J, JB, JJ, C, F, G		2.0
Pivoted and rigidly Guided	BB, DB, SB		2.0
Supported but not Rigidly Guided	TC, H, HB, HH		4.0
Supported but not Rigidly Guided	BB, DB, SB		4.0

**Long Stroke Cylinders**

When considering the use of long stroke cylinders, the piston rod should be of sufficient diameter to provide the necessary column strength.

For tensile (pull) loads, rod strength is unaffected by stroke length.

For long stroke cylinders, the use of stop tubes should be considered, to reduce bearing stress. The Piston Rod Selection Chart on page 33 provides guidance where unusually long strokes are required.

**An Introduction to Cushioning**

Cushioning is recommended as a means of controlling the deceleration of masses, or for applications where piston speeds are in excess of 0.1m/s and the piston will make a full stroke. Cushioning extends cylinder life and reduces undesirable noise and hydraulic shock.

Deceleration devices or built-in 'cushions' are optional and can be supplied at the head end, cap end, or at both ends of the cylinder without affecting its envelope or mounting dimensions.

**Standard Cushioning**

Ideal cushion performance shows an almost uniform absorption of energy along the cushioning length, as shown. Many forms of cushioning exist, and each has its own specific merits and advantages.

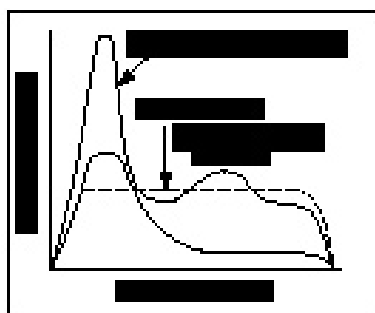

In order to cover the majority of applications, 2H cylinders are supplied with stepped cushioning as standard. Final speed may be adjusted using the cushion screws.

Note that cushion performance will be affected by the use of water or high water based fluids. Please consult the factory for details.

**Alternative Forms of Cushioning**

To complement the standard offering of stepped cushioning, special cushions can be designed to suit applications where the energy to be absorbed exceeds the standard cushion performance. Please consult the factory for further details.

**Cushion Calculations**

Modelling the cushion performance on uniform deceleration, the formulae below can be used to determine the approximate force developed in the cushion chamber when decelerating a load.

**Formulae**

$F = ma + A_d P/10 + mgsin\alpha - f$   
(for inclined or vertically downward direction of mass)

$F = ma + A_d P/10 - mgsin\alpha - f$   
(for inclined or vertically upward direction of mass)

Where:

F = total force acting on the cushion chamber in Newtons  
m = mass of load in kilogrammes (including piston, rod, and rod end accessories, see table and pages 27 to 29)

a = deceleration in m/s<sup>2</sup>, derived from the formula

$$a = \frac{v^2}{2s \times 10^{-3}}$$

where: v = piston velocity in m/s  
s = cushion length in mm

A<sub>d</sub> = area acted on by pump pressure in mm<sup>2</sup> (see page 32)

P = pump pressure in bar

g = acceleration due to gravity = 9.81m/s<sup>2</sup>

α = angle to the horizontal in degrees

f = friction forces in Newtons = mg x 0.15

**Example**

The following example shows how to calculate horizontal deceleration (α=0).

Selected bore/rod 127/50.8mm (No. 1 rod)  
Pressure = 35 bar  
Mass = 2268kg  
Velocity = 0.6m/s  
Cushion length = 27mm  
Friction coefficient = 0.15 or 3337N.

$$F = ma + A_d P/10$$

where  $a = \frac{0.6^2}{2 \times 27 \times 10^{-3}} = 6.66 \text{ m/s}^2$

and  $F = 2268 \times 6.66 + 12670 \times 35/10 - 3337 = 56128\text{N}$

The total deceleration force is developed by the fluid compressed in the cushion chamber.

This pressure is approximately equal to the force divided by the annular area (cylinder bore area - rod area):

$$\frac{56128\text{N}}{12670\text{mm}^2 - 2020\text{mm}^2} = 5.3\text{N/mm}^2 \text{ or } 53 \text{ bar.}$$

This induced pressure should not exceed 320 bar.

**Cushion Length & Piston and Rod Mass**

Where specified, 2H cylinders incorporate the longest cushion sleeve and spear that can be accommodated within the standard envelope without reducing the rod bearing and piston bearing lengths (see table of cushion lengths below). Cushions are adjustable via recessed needle valves.

Bore Ø	Rod No.	MM Rod Diameter	Cushion Length		Piston & Rod at Zero stroke kg	Rod only per 10mm Stroke kg
			Head	Cap		
38.1 (1 1/2")	1	15.9 (5/8")	28.6	30.2	0.45 0.73	0.02 0.04
	2	25.4 (1")				
50.8 (2")	1	25.4 (1")	28.6	28.6	0.97 1.49	0.04 0.07
	2	34.9 (1 3/8")				
63.5 (2 1/2")	1	25.4 (1")	28.6	28.6	1.36 2.66 1.87	0.04 0.12 0.07
	2	44.5 (1 3/4")				
	3	34.9 (1 3/8")				
82.6 (3 1/4")	1	34.9 (1 3/8")	34.9	33.3	2.83 4.34 3.64	0.07 0.16 0.12
	2	50.8 (2")				
	3	44.5 (1 3/4")				
101.6 (4")	1	44.5 (1 3/4")	34.9	31.8	4.99 7.71 5.68	0.12 0.25 0.16
	2	63.5 (2 1/2")				
	3	50.8 (2")				
127.0 (5")	1	50.8 (2")	27.0	28.6	8.73 15.70 10.75 13.19	0.16 0.48 0.25 0.35
	2	88.9 (3 1/2")				
	3	63.5 (2 1/2")				
	4	76.2 (3")				
152.4 (6")	1	63.5 (2 1/2")	33.3	38.1	14.98 23.88 17.49 20.09	0.25 0.63 0.35 0.48
	2	101.6 (4")				
	3	76.2 (3")				
	4	88.9 (3 1/2")				
177.8 (7")	1	76.2 (3")	46.0 42.9 46.0 33.3	49.2	22.28 39.59 25.03 29.01	0.35 0.98 0.48 0.63
	2	127.0 (5")				
	3	88.9 (3 1/2")				
	4	101.6 (4")				
203.2 (8")	1	88.9 (3 1/2")	52.4 49.2 33.3 42.9	50.8	33.04 54.78 37.11 47.91	0.48 1.19 0.63 0.98
	2	139.7 (5 1/2")				
	3	101.6 (4")				
	4	127.0 (5")				
	5	127.0 (5")				
254.0 (10")	1	127.0 (5")	54.0	50.8	76.38 105.39	0.98 1.92
	2	177.8 (7")				
304.8 (12")	1	139.7 (5 1/2")	54.0	50.8	120.47 177.25	1.19 2.84
	2	215.9 (8 1/2")				

**Pressure Limitations – Introduction**

The pressure limitations of a hydraulic cylinder must be reviewed when considering its application. To assist the designer in obtaining the optimum performance from a cylinder, the following guidelines are provided. If in doubt, please consult the factory.

**Low Pressure Operation**

At low operating pressures, a wide range of application factors begin to affect cylinder performance. As a result, consideration should be given to factors such as seal friction and mounting alignment when selecting a cylinder for low pressure use. Low Friction seals are available to special order, to optimise performance at low pressures. For further information, please consult the factory.

**Maximum Pressure**

Series 2H cylinders are recommended for pressures up to 210 bar for heavy-duty service with hydraulic oil. The 4:1 design factor rating shown is conservative for continuous severe applications. Safety factors at other pressures can be calculated from this rating. In addition, mounting styles, stroke, etc., should be considered because of the limiting effect they may have on these ratings.

The designer must, however, take account of fatigue stress which may restrict the cylinder to a lower pressure. Three main areas of cylinder design may be affected: the cylinder body (pressure envelope), the cylinder mountings, and the piston rod.

The maximum pressures indicated in the tables opposite are based on pure tensile and compressive loadings, without the presence of any bending stresses. Where it is impractical to avoid side loadings, eg: by the use of pivot mountings, please consult the factory giving full details of the application.

**Cylinder Body (Pressure Envelope)**

In many applications, the pressure developed within a cylinder may be greater than the working pressure, due to pressure intensification across the piston and cushioning, e.g. meter-out circuits. In most cases, this intensification does not affect the cylinder mountings or piston rod threads in the form of increased loading. This induced pressure should not exceed 320 bar. If in doubt, please consult the factory.

For more comprehensive information about pressure limitations for individual cylinders, please refer to the European cylinder InPHorm selection program.

**Maximum Pressure Ratings**

Bore Ø (with rod no. 1)	4 : 1 Design Factor (yield)		Heavy-duty Service	
	(bar)	(psi)	(bar)	(psi)
38.1 (1½")	145	2040	210	3000
50.8 (2")	165	2340	210	3000
63.5 (2½")	135	1920	210	3000
82.6 (3¼")	150	2100	210	3000
101.6 (4")	145	1970	210	3000
127.0 (5")	135	1900	210	3000
152.4 (6")	150	2100	210	3000
177.8 (7")	130	1840	210	3000
203.2 (8")	145	1980	210	3000
254.0 (10")	155	2200	210	3000
304.8 (12")	170	2380	210	3000

**Maximum Pressure for H and J Mountings**

Bore Ø	Style H Mounting <sup>1</sup> Pull applications (bar)					Style J Mounting <sup>2</sup> Push applications (bar)				
	Rod Numbers					Rod Numbers				
	1	2	3	4	5	1	2	3	4	5
38.1 (1½")	210	210	-	-	-	180	110	-	-	-
50.8 (2")	210	210	-	-	-	180	110	-	-	-
63.5 (2½")	210	210	210	-	-	180	110	130	-	-
82.6 (3¼")	210	210	210	-	-	180	110	145	-	-
101.6 (4")	210	210	210	-	-	180	110	125	-	-
127.0 (5")	150	210	180	195	-	160	60	115	85	-
152.4 (6")	150	210	180	195	-	130	60	100	75	-
177.8 (7")	110	150	120	125	-	110	40	90	70	-
203.2 (8")	110	150	120	-	130	70	40	55	-	45
254.0 (10")	180	210	-	-	-	72	46	-	-	-
304.8 (12")	135	210	-	-	-	Not recommended		-	-	-

<sup>1</sup> For pressures exceeding those shown use mounting HB or HH  
<sup>2</sup> For pressures exceeding those shown use mounting JB or JJ

**Ports – Standard Ports**

Series 2H cylinders are supplied as standard with BSPP ports to ISO 228/1, spot faced for sealing washers. Metric threaded ports to DIN 3852 Pt.1 and ISO 6149, or NPTF ports in sizes as shown for BSPP ports, can be supplied if specified. The ISO 6149 port incorporates a raised ring in the spot face for identification.

Where required, oversize or additional ports can be supplied on the sides of heads and caps that are not occupied by cushion valves. Refer to the tables of port sizes opposite.

**ISO 6149 Port Identification**

Raised F  
within S<sub>φ</sub>

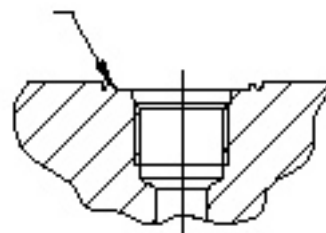

All dimensions are in millimetres unless otherwise stated.

**Upsize Ports**

For higher speed applications, upsize ports can be supplied in all bore sizes, but are not available on Style JJ mounting (please consult the factory). Ports one size larger than standard are the maximum that can be accommodated in most heads or caps within the standard envelope dimensions. All upsize metric, BSPT or NPTF ports require welded port bosses. The bosses protrude from the side of the cylinder. Port sizes are shown in the tables opposite.

Note that Y and P dimensions may vary slightly to accommodate upsize ports – please contact the factory where these dimensions are critical.

**Port Size and Piston Speed**

The tables opposite show piston speeds for standard and upsize ports and connecting lines where the velocity of the fluid is 5m/s. Due to piston rod displacement, the flow at the cap end port will be greater than that at the head end, at the same piston speed. If the desired piston speed results in a fluid flow in excess of 5m/s, larger lines with two ports per cap should be considered. Parker recommends that a flow rate of 12m/s in connecting lines should not be exceeded.

**Speed Limitations**

Where large masses are involved, or piston speeds exceed 0.1m/s and the piston will make a full stroke, cushions are recommended – see page 35. For cylinders with upsize ports and with a fluid velocity exceeding 8m/s into the cap end, please consult the factory with details of the application.

**Ports, Air Bleeds and Cushion Adjustment Location**

The table below shows standard positions for ports, and cushion adjusting screws where fitted. However, by specifying the position numbers for the desired locations for head and cap ports, many mounting styles can be assembled with ports located at 90° or 180° from standard. In these cases, cushion needle and check valves are also repositioned, where fitted, since their relation with the port position does not change. Air bleeds, see pages 7 and 39, may be fitted in unoccupied faces of the head or cap, depending on mounting.

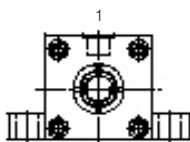

Bore Ø	Standard Ports				
	Port Size BSPP	Port size Metric	Tube Bore mm	l/min. flow at 5m/sec <sup>1</sup>	Piston Speed in m/sec
38.1 (1½")	G½	M22x1.5	13	40	0.58
50.8 (2")	G½	M22x1.5	13	40	0.33
63.5 (2½")	G½	M22x1.5	13	40	0.21
82.6 (3¼")	G¾	M27x2	15	53	0.17
101.6 (4")					0.11
127.0 (5")					0.07
152.4 (6")	G1	M33x2	19	85	0.08
177.8 (7")	G1¼	M42x2	24	136	0.09
203.2 (8")	G1½	M48x2	30	212	0.11
254.0 (10")	G2	M60x2	38	340	0.11
304.8 (12")	G2½	–	50	589	0.14

Bore Ø	Rod No	Upsize Ports				
		Port Size BSPP	Port size Metric	Tube Bore mm	l/min. flow at 5m/sec <sup>1</sup>	Piston Speed in m/sec
38.1 (1½")	1	G¾ <sup>3</sup> G¾ <sup>2</sup>	M27x2 <sup>2</sup>	15	53	0.78
	2					
50.8 (2")	1	G¾ <sup>3</sup> G¾ <sup>2</sup>	M27x2 <sup>2</sup>	15	53	0.44
	2					
63.5 (2½")	1	G¾	M27x2	15	53	0.28
82.6 (3¼")	2	G1	M33x2	19	85	0.27
101.6 (4")	All					0.18
127.0 (5")	All					0.11
152.4 (6")	All	G1¼	M42x2	24	136	0.12
177.8 (7")	All	G1½	M48x2	30	212	0.14
203.2 (8")	All	G2	–	38	340	0.18
254.0 (10")	All	–	–	–	–	–
304.8 (12")	All	–	–	–	–	–

<sup>1</sup> This refers to fluid velocity in connecting lines, not piston velocity  
<sup>2</sup> Supplied with welded port bosses at both head and cap  
<sup>3</sup> Supplied with welded port bosses at cap only

**Manifold Ports**

Manifold ports are available on all mounting styles to special order. Side mounted cylinders (Style C) can be supplied with the cylinder ports arranged for mounting and sealing to a manifold surface – see page 31.

**Flange Ports**

Flange ports are available on most large bore 2H series cylinders. Please consult the factory for details.

Positions of Ports and Cushion Screws in Head and Cap		Mounting Styles																														
		TB, TC, TD, J, JB, H, HB, BB & SBa				JJ				HH				C		D		DB				DD				G & F						
Head	Port	1	2	3	4	1	2	3	4	1	2	3	4	1	1	3	1	2	3	4	1	2	3	4	1	2	3	4	1	2	3	4
	Cushion	2	3	4	1	3	3	1	1	3	3	1	1	2	3	1	3	4	1	2	3	4	1	2	2	2	4	1				
Cap	Port	1	2	3	4	1	2	3	4	1	2	3	4	1	1	2	3	4	1	3	1	2	3	4	1	2	3	4	1	2	3	4
	Cushion	2	3	4	1	3	4	1	2	3	3	1	1	2	3	4	1	2	3	1	3	4	1	2	2	2	4	1				

All dimensions are in millimetres unless otherwise stated.

Fluid Group	Seal Materials – a combination of:	Fluid Medium to ISO 6743/4-1982	Temperature Range
1	Nitrile (NBR), PTFE, enhanced polyurethane (AU)	Mineral Oil HH, HL, HLP, HLP-D, HM, MIL-H-5606 oil, air, nitrogen	-20°C to +80°C
2	Nitrile (NBR), PTFE	Water glycol (HFC)	-20°C to +60°C
5	Fluorocarbon elastomer (FPM), PTFE	Fire resistant fluids based on phosphate esters (HFD-R) Also suitable for hydraulic oil at high temperatures or in hot environments. <b>Not suitable for use with Skydrol.</b> See fluid manufacturer's recommendations.	-15°C to +150°C
6	Various compounds including nitrile, polyamide, enhanced polyurethane, fluorocarbon elastomers and PTFE	Water Oil in water emulsion 95/5 (HFA)	+5°C to +50°C
7		Water in oil emulsion 60/40 (HFB)	+5°C to +50°C

### Operating Medium

Sealing materials used in standard cylinders are suitable for use with most petroleum-based hydraulic fluids.

Special seals are available for use with water-glycol or water-in-oil emulsions, and with fluids such as fire-resistant synthetic phosphate ester and phosphate ester-based fluids.

The table above is a guide to the sealing compounds and operating parameters of the materials used for rod gland, piston and body seals. If there is any doubt regarding seal compatibility with the operating medium, please consult the factory.

#### Notes

**Group 1 Seals** are manufactured from an enhanced polyurethane and do not require a gland seal back-up washer. They should not be used if the working fluid is water glycol.

**Group 6 Seals** – System pressure should not exceed 70 bar when using HFA fluids.

### Green Fluids

Special seals for use with specific 'green fluids' are available to special order. Please consult the factory for details.

### External Fluids

The environment in which a cylinder is used may cause fluids such as cutting fluids, coolants, and wash down fluids, to come into contact with the external surfaces of the cylinder. These fluids may attack the cylinder O-ring seals, the piston rod wiper and/or the rod seal, and must be taken into account when selecting and specifying seal compounds.

### Temperature

Group 1 seals can be operated at temperatures between -20°C and +80°C. Where operating conditions result in temperatures outside these limits, special seal compounds may be required to ensure satisfactory service life – please consult the factory.

For seal groups 2, 5, 6 and 7, where operating conditions fall outside of those specified in the table, please contact the factory.

### Special Seal Designs and Materials

Group 1 seals are fitted as standard to 2H cylinders. For other duties, the optional seal groups 2, 5, 6 and 7 are available – please quote in the cylinder order code, shown on page 43. (Please note that system pressure for Group 6 seals for use with HFA fluids should not exceed 70 bar). Special seals can

also be supplied – please consult the factory with details of the application. Please insert an S (Special) in the order code and specify fluid medium when ordering.

### Low Friction Seals

For applications where very low friction and an absence of stick-slip are important, the option of low friction seals is available. In low pressure applications, their use should also be considered. If in doubt, please consult the factory. The gland seals comprise two low friction PTFE stepped seals and a conventional double lip wiper.



### Water Service

Special modifications to cylinders are available for high water content fluids. Modifications include a stainless steel piston rod with lipseal piston, and plating of internal surfaces. When ordering, please specify the maximum operating pressure or load/speed conditions, as the stainless steel rod is of lower tensile strength than the standard material.

### Pure Water

Parker Hannifin can also supply cylinders for use with pure water as the fluid medium. Please consult the factory.

**Warranty** Parker Hannifin warrants cylinders modified for water or high water content fluid service to be free of defects in materials or workmanship, but cannot accept responsibility for premature failure caused by excessive wear resulting from lack of lubricity, or where failure is caused by corrosion, electrolysis or mineral deposits within the cylinder.

### Filtration

For maximum component life, the system should be protected from contamination by effective filtration. Fluid cleanliness should be in accordance with ISO 4406. The quality of filtration should be in accordance with the appropriate ISO standards.

The rating of the filter medium depends on the system components and the application. The minimum required for hydraulic systems should be class 19/15 to ISO 4406, which equates to 24µ(β10≥75) to ISO 4572.

All dimensions are in millimetres unless otherwise stated.

**Air Bleeds**

The option of bleed screws, illustrated on page 7, is available at either or both ends of the cylinder, at any position except in the port face – see page 37. The selected positions should be shown in the order code – see page 43. Cylinders with bore sizes of 38.1mm (1½”) are fitted with M5 bleed screws; for bore sizes of 50.8mm (2”) and above, M8 bleed screws are fitted.

**Gland Drains**

The tendency of hydraulic fluid to adhere to the piston rod can result in an accumulation of fluid in the cavity behind the gland wiperseal under certain operating conditions (see page 7). This may occur with long stroke cylinders where there is a constant back pressure as in differential circuitry, or where the ratio of the extend speed to the retract speed is greater than 2 : 1.

A 1/8” NPTF gland drain port can be provided in the retainer on all cylinders up to and including 203.2mm (8”) bore sizes, except 38.1mm (1½”) with no. 1 rod. For 38.1mm (1½”) bore cylinders with no.2 rod, the retainer thickness is increased to 15.9mm (5/8”). For 38.1mm (1½”) bore cylinders with no.1 rod, the drain port is located in the head end adjacent to the port.

Gland drains should be piped back to the fluid reservoir, which should be located below the level of the cylinder.

**Stroke Limiters**

Where absolute precision in stroke length is required, a screwed adjustable stop can be supplied at the cap end. Several types are available – the illustration shows a design suitable for infrequent adjustment of an uncushioned cylinder. Please contact the factory, specifying details of the application and the adjustment required.

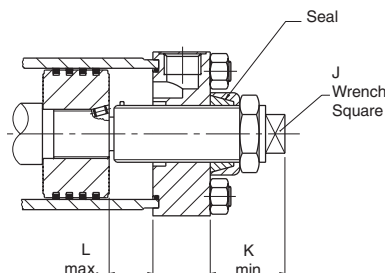

Bore Ø	J	K min.	L max.
38.1 (1½")	11	55	127.0
50.8 (2")	17	75	203.2
63.5 (2½")	17	75	228.6
82.6 (3¼")	22	85	228.6
101.6 (4")	24	70	457.2
127.0 (5")	32	70	508.0
152.4 (6")	41	75	508.0
177.8 (7")	50	75	508.0
203.2 (8")	60	80	508.0

**Rod Locking Devices**

These units provide positive locking of the piston rod. They require hydraulic pressure to release, while loss of pressure causes the clamp to operate, allowing them to be used as a fail-safe device. Please consult the factory for further information.

**Single-Acting Cylinders**

Standard 2H series cylinders are of the double-acting type. They are also suitable for use as single-acting cylinders, where the load or other external force is used to return the piston after the pressure stroke. Cast iron piston rings should not be used with single-acting cylinders.

**Spring-Returned, Single-Acting Cylinders**

Series 2H single-acting cylinders can also be supplied with an internal spring to return the piston after the pressure stroke. Please supply details of load conditions and friction factors, and advise whether the spring is required to advance or return the piston rod.

On spring-returned cylinders, it is recommended that tie rod extensions be specified on the cylinder end in which the spring is located to allow the spring to be ‘backed off’ until compression is relieved. Tie rod nuts should be welded to the tie rods at the opposite end of the cylinder, to further assure safe disassembly. Please consult the factory when ordering spring-returned cylinders.

**Multiple Stroke Positioning**

To obtain linear force in one plane with controlled stopping at intermediate points, several designs are available. For three stopped positions, it is common practice to mount two standard single rod Style H cylinders back-to-back, or to use through-tie rods. By extending or retracting the stroke of each cylinder independently, it is possible to achieve three positions at the piston ends. An alternative technique is to use a tandem cylinder with an independent piston rod in the cap section. Please consult the factory for further details.

**Rod End Bellows**

Unprotected piston rod surfaces which are exposed to contaminants with air hardening properties should be protected by rod end bellows. Longer rod extensions are required to accommodate the collapsed length of the bellows. Please consult the factory for further information.

**Metallic Rod Wipers**

Metallic rod wipers replace the standard wiper seal, and are recommended where dust, ice or splashing might damage the wiper seal material. Metallic rod wipers do not affect cylinder dimensions.

**DC Proximity Sensors**

These can be fitted to give reliable end of stroke signals. See catalogue 0810 for details.

**Position Feedback**

Linear position transducers of various types are available for 2H series cylinders. See catalogue 1175 for details.

All dimensions are in millimetres unless otherwise stated.

**Service Assemblies and Seal Kits**

Service Assembly Kits and Seal Kits for 2H cylinders simplify the ordering and maintenance processes. They contain sub-assemblies which are ready for installation, and are supplied with full instructions. When ordering Service Assemblies and Seal Kits, please refer to the identification plate on the cylinder body, and supply the following information:

**Serial Number - Bore - Stroke - Model Number - Fluid Type**

**Key to Part Numbers**

- 1 Head
- 7 Cap
- 14 Gland/bearing cartridge
- 15 Cylinder body
- 17 Piston
- 18 Cushion sleeve
- 19 Tie rod
- 23 Tie rod nut
- 26 Back-up washer – only on 203.2mm to 304.8mm (8" to 12") bore cylinders
- 27 Retainer

- 61<sup>1</sup> Piston rod – double (weaker<sup>2</sup>) rod, cushion one end
- 69 O-ring – needle valve and check valve screws
- 69a O-ring – cartridge-type needle valve
- 70 Needle valve, cushion adjustment – bore sizes above 63.5mm (2½")
- 70a Needle valve assembly, cartridge type – bore sizes up to 63.5mm (2½")
- 71 Ball – cushion check valve – bore sizes above 101.6mm (4")
- 72 Cushion check valve screw – bore sizes above 101.6mm (4")
- 73 Floating cushion bush
- 74 Retaining ring for cushion bush
- 119 PTFE rings (Hi-Load piston)
- 120 Rubber pre-load rings (Hi-Load piston)
- 121 Wear rings (Hi-Load piston)

<sup>1</sup> Not illustrated  
<sup>2</sup> See page 26 – double rod strength

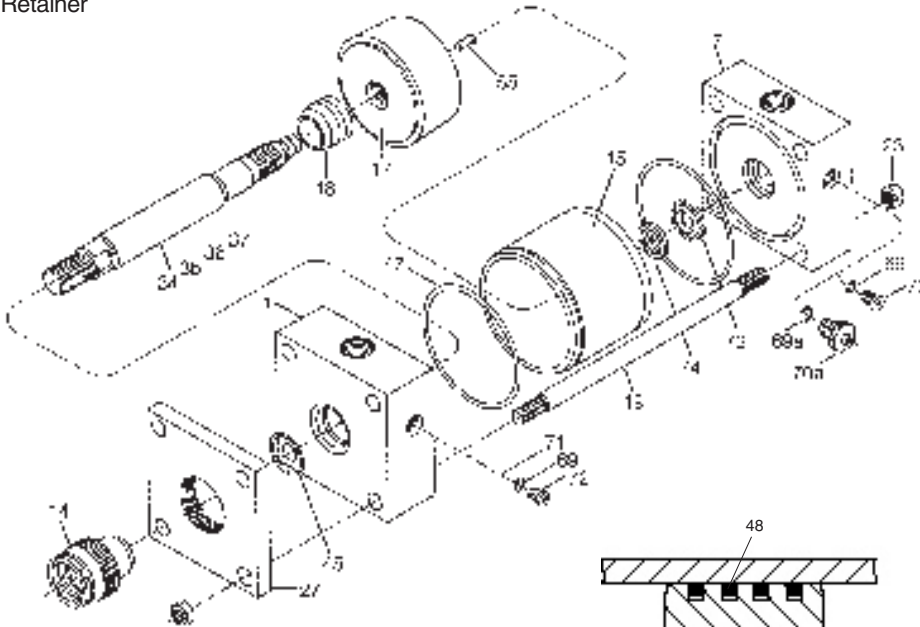

Piston Rod Ø	Gland Cartridge Wrench	Spanner Wrench
15.9	69590	11676
25.4	69591	11676
34.9	69592	11703
44.5	69593	11677
50.8	69594	11677
63.5	69595	11677
76.2	69596	11677
88.9	69597	11677
101.6	69598	11677
127.0	69599	11678
139.7	69600	11678
177.8	–	–
215.9	–	–

- 34 Piston rod – single rod, no cushion
- 35 Piston rod – single rod, cushion at head end
- 36 Piston rod – single rod, cushion at cap end
- 37 Piston rod – single rod, cushion at both ends
- 40 Wiperseal – for gland
- 41 Lipseal – for gland
- 42 Lipseal – for Lipseal piston
- 43 Back-up washer – for gland lipseal 41 (Groups 2, 5, 6 & 7 seals)
- 44 Back-up washer – for Lipseal piston
- 45 O-ring – gland/head
- 47 O-ring – cylinder body
- 48 Cast iron piston ring
- 55 Locking pin – piston/rod
- 57<sup>1</sup> Piston rod – double (stronger<sup>2</sup>) rod, no cushion
- 58<sup>1</sup> Piston rod – double (stronger<sup>2</sup>) rod, cushion one end
- 60<sup>1</sup> Piston rod – double (weaker<sup>2</sup>) rod, no cushion

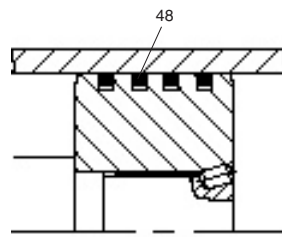

**Cast Iron Piston**

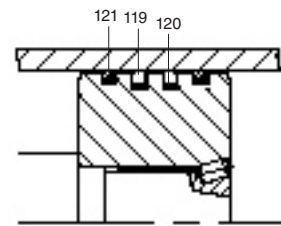

**Hi-Load Piston**

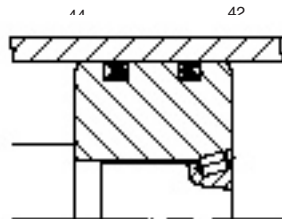

**Lipseal Piston**

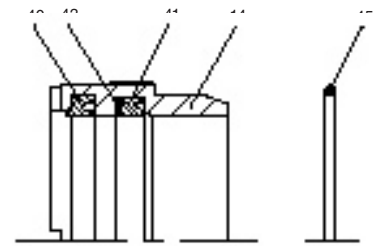

**Gland Cartridge and Seals**



**Piston and Gland Service Kits**

(see key to part numbers opposite)

**Gland Service Cartridge Kit** Contain items 14, 40, 41, 43, 45. Where the original gland incorporates a gland drain, please consult the factory.

**Gland Service Kit** Contain items 40, 41, 43, 45.

Piston Rod Ø	Gland Service Cartridge Kit * Standard Seals	Gland Service Kit * Standard Seals
15.9 (5/8")	RG2HLTS061	RK2HLTS061
25.4 (1")	RG2HLTS101	RK2HLTS101
34.9 (1 3/8")	RG2HLTS131	RK2HLTS131
44.5 (1 3/4")	RG2HLTS171	RK2HLTS171
50.8 (2")	RG2HLTS201	RK2HLTS201
63.5 (2 1/2")	RG2HLTS251	RK2HLTS251
76.2 (3")	RG2HLTS301	RK2HLTS301
88.9 (3 1/2")	RG2HLTS351	RK2HLTS351
101.6 (4")	RG2HLTS401	RK2HLTS401
127.0 (5")	RG2HLTS501	RK2HLTS501
139.7 (5 1/2")	RG2HLTS551	RK2HLTS551
127.0 (5") <sup>1</sup>	RG902HTS501	RK902HTS501
139.7 (5 1/2") <sup>2</sup>	RG922HTS551	RK922HTS551
177.8 (7") <sup>1</sup>	RG902HLF701	RK902HLF701
215.8 (8 1/2") <sup>2</sup>	RG922HLF851	RK922HLF851

<sup>1</sup> 254.0mm (10") bore size only    <sup>2</sup> 304.8 mm (12") bore size only

**Piston Service Kit, Cast Iron Rings** Contains two of item 47 plus four of item 48.

**Piston Service Kit, Lipseal Piston** Contains two each of items 42, 47 and 44.

**Piston Service Kit, Hi-Load Piston** Contains two each of items 47, 119, 120 and 121.

Bore Ø	Piston Service Kit Cast Iron Rings	Piston Service Kit * Lipseal Piston	Piston Service Kit * Hi-Load Piston
38.1 (1 1/2")	PR152H001	PK152HLL01	PK152HK001
50.8 (2")	PR202H001	PK202HLL01	PK202HK001
63.5 (2 1/2")	PR252H001	PK252HLL01	PK252HK001
82.6 (3 1/4")	PR322H001	PK322HLL01	PK322HK001
101.6 (4")	PR402H001	PK402HLL01	PK402HK001
127.0 (5")	PR502H001	PK502HLL01	PK502HK001
152.4 (6")	PR602H001	PK602HLL01	PK602HK001
177.8 (7")	PR702H001	PK702HLL01	PK702HK001
203.2 (8")	PR802H001	PK802HLL01	PK802HK001
254.0 (10")	PR902H001	PK902HLL01	PK902HK001
304.8 (12")	PR922H001	PK922HLL01	PK922HK001

**\* Seal Groups – Ordering**

The part numbers shown in the tables above are for Group 1 seals. For Group 2, 5, 6 or 7 gland seals, substitute 'AHL' for 'HLTS' where used, and replace the '1' at the end of the number sequence with '2', '5', '6' or '7'. For example, a Group 5 RG Gland Cartridge Kit for a 50.8mm rod will be RG2AHL205. For Group 2, 5, 6 or 7 piston seals, substitute a '2', '5', '6' or '7' for the '1' at the end of the number sequence.

All dimensions are in millimetres unless otherwise stated.

**Contents of Service Assembly Kits**

(see key to part numbers opposite)

**Head Assembly**

Non-cushioned: 1, 26, 47  
Cushioned: 1, 26, 47, 69, (69a), 70, (70a)

**Cap Assembly**

Non-cushioned: 7, 26, 47  
Cushioned: 7, 26, 47, 69, (69a), 70, (70a), 73, 74

**Cylinder Body**

All types: 15

**Cushion Screw/Cartridge Assembly**

Screw type: 69, 70  
Cartridge type: 69a, 70a

**Check Valve Screw Assembly**

Screw type: 69, 71, 72 (bore sizes above 101.6mm)

**Piston Rod Assemblies**

These kits contain a fully assembled piston and rod assembly which is ready to install. They comprise a piston plus a rod from the types listed below.

**Piston Types**

Cast Iron Ring: 17, 48  
Lipseal: 17, 42, 44  
Hi-Load: 17, 119, 120, 121

**Rod Types**

Single rod, non-cushioned: 34  
Single rod, cushioned head: 35, 18  
Single rod, cushioned cap: 36  
Single rod, cushioned both ends: 37, 18

Double rod, non-cushioned: 57, 60,  
Double rod, cushioned stronger end: 58, 60, 18  
Double rod, cushioned weaker end: 58, 61, 18  
Double rod, cushioned both ends: 58, 61, 18 x 2

**Tie Rod Torques**

Please refer to the table on page 31.

**Repairs**

Although 2H cylinders are designed to make on-site maintenance or repairs as easy as possible, some operations can only be carried out in our factory. It is standard policy to fit a cylinder returned to the factory for repair with those replacement parts which are necessary to return it to 'as good as new' condition. Should the condition of the returned cylinder be such that repair would be uneconomical, you will be notified.

**254.0mm & 304.8mm (10" & 12") Bores Only**

**Rod End Details – All Except J, JB and JJ Mountings**

**Rod End Style 4**

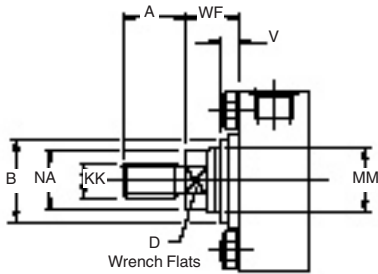

**Rod End Style 8**

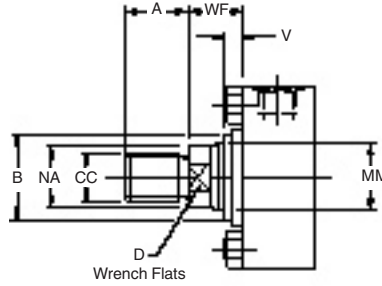

**Rod End Style 9**

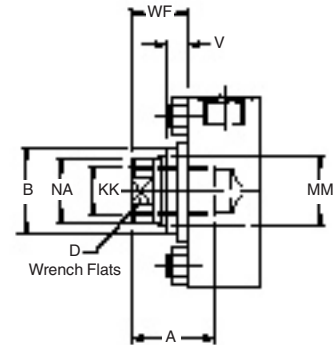

**Rod End Details – J and JB Mountings**

**Rod End Style 4**

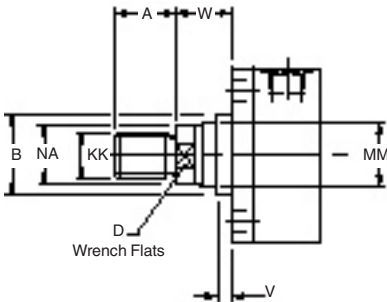

**Rod End Style 8**

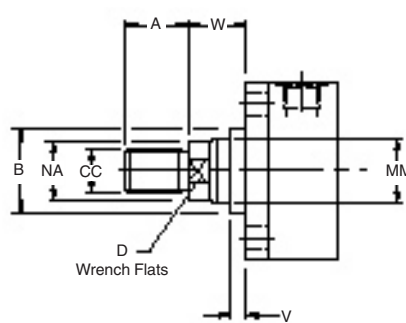

**Rod End Style 9**

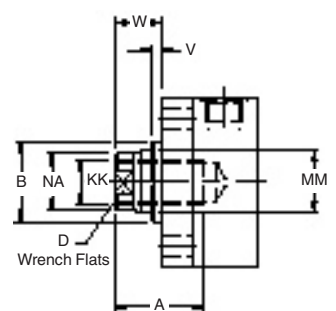

**Rod End Details – JJ Mounting**

**Rod End Style 4**

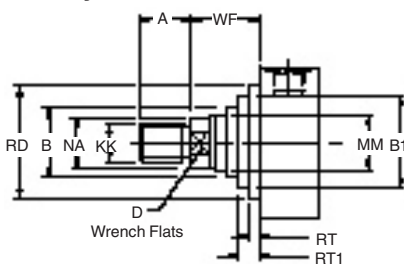

**Rod End Styles 4 & 8**

Style 4 rod ends are recommended for all applications in which the work piece is secured against the rod shoulder. Where the work piece is not shouldered, Style 8 rod ends are recommended. If rod end style is not specified, Style 4 will be supplied.

**Rod End Style 9**

For applications where a female thread is required.

**Rod End Style 3**

Non-standard piston rod ends are designated 'Style 3'. A dimensional sketch or description should accompany the order. Please specify dimensions KK or CC, and A.

**Rod End Dimensions – 254.0mm & 304.2mm (10" & 12") Bore Sizes Only**

Bore Ø	Rod No.	MM Rod Diameter	Style 4 & 9		Style 8		A	B <sup>+0.00</sup> <sub>-0.13</sub>	D	NA	V	W	WF	JJ Mount Only			
			KK Metric	KK UNF	CC Metric	CC UNF								B1	RD max.	RT	RT1
254.0 (10")	1	127.0 (5")	M90x2	3 1/2 - 12	M110x2	4 3/4 - 12	127	146.0	110	123.8	7	32	74.9	–	241.3	25.4	–
	2	177.8 (7")	M100x2	4 - 12	M130x2	4 3/4 - 12	127	196.3	150	174.6	13	38	81.0	214.3	273.1	28.6	41.7
304.8 (12")	1	139.7 (5 1/2")	M100x2	4 - 12	M130x2	5 1/4 - 12	140	158.7	120	136.5	7	32	82.0	–	206.4	33.3	–
	2	215.9 (8 1/2")	M115x2	4 1/2 - 12	M130x2	5 1/4 - 12	140	234.9	180	212.7	13	38	87.2	260.3	336.6	28.6	46.1

All dimensions are in millimetres unless otherwise stated.

# How To Order

# Tie Rod Cylinders 2H Series

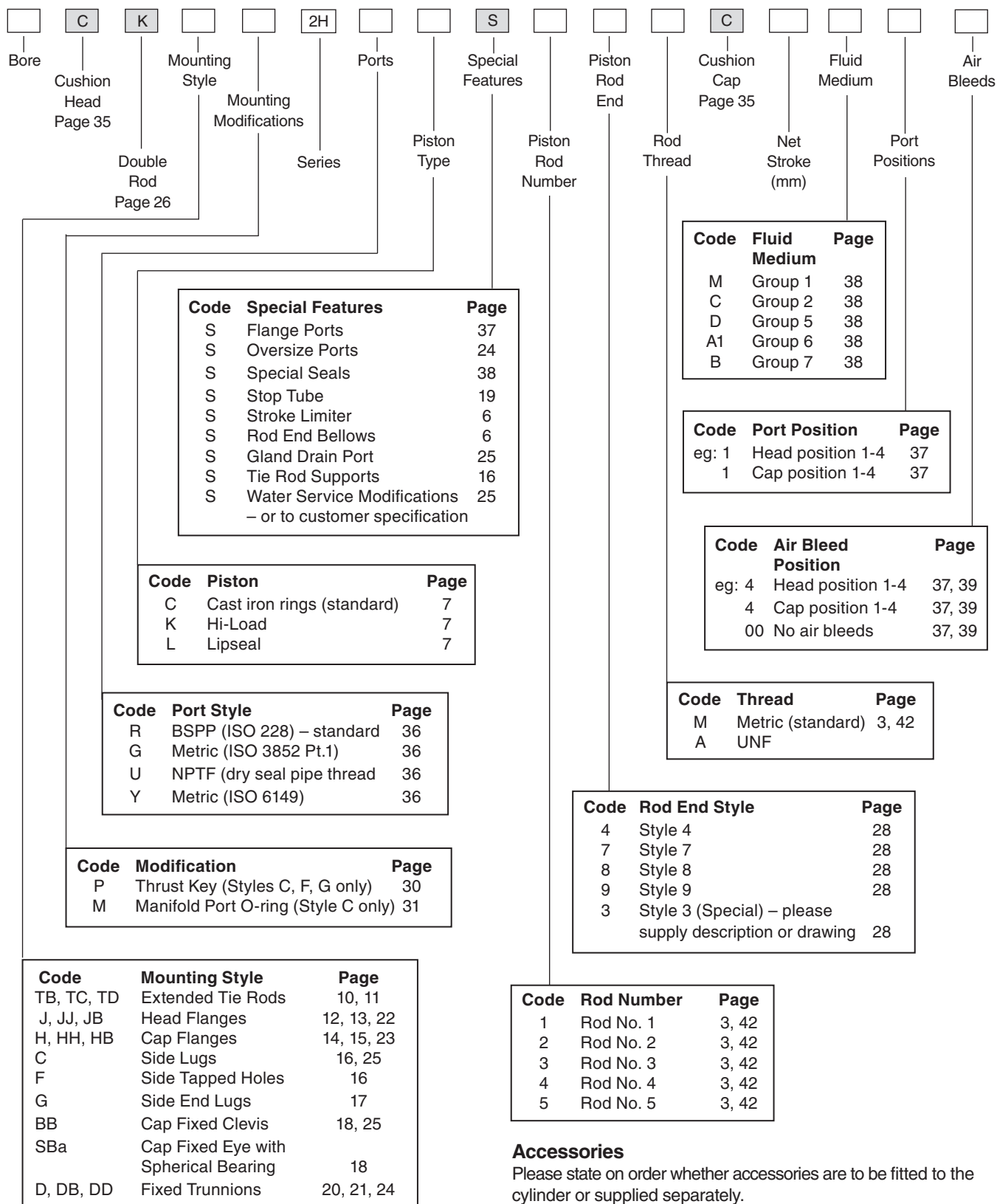

### Accessories

Please state on order whether accessories are to be fitted to the cylinder or supplied separately.

### Key

Required for basic cylinder

Indicate optional features or leave blank



### Double Rod Cylinders – Example

100	K	JJ	2H	R	K	1	4	M	1	4	M	125	D	11	44
-----	---	----	----	---	---	---	---	---	---	---	---	-----	---	----	----

# Hydraulics Group Sales Offices

## Europe

### **Austria**

#### **Wiener Neustadt**

Tel: +43 (0)2622 23501

Fax: +43 (0)2622 66212

### **Austria**

#### **Wiener Neustadt**

**(Resp. for East Europe)**

Tel: +43 (0)2622 23501-970

Fax: +43 (0)2622 23501-977

### **Belgium**

#### **Nivelles**

Tel: +32 (0)67 280 900

Fax: +32 (0)67 280 999

### **Czech Republic**

#### **Klecany**

Tel: +420 284 083 111

Fax: +420 284 083 112

### **Denmark**

#### **Ballerup**

Tel: +45 4356 0400

Fax: +45 4373 3107

### **Finland**

#### **Vantaa**

Tel: +358 20 753 2500

Fax: +358 20 753 2200

### **France**

#### **Contamine-sur-Arve**

Tel: +33 (0)450 25 80 25

Fax: +33 (0)450 25 24 25

### **Germany**

#### **Kaarst**

Tel: +49 (0)2131 4016 0

Fax: +49 (0)2131 4016 9199

### **Ireland**

#### **Dublin**

Tel: +353 (0)1 293 9999

Fax: +353 (0)1 293 9900

### **Italy**

#### **Corsico (MI)**

Tel: +39 02 45 19 21

Fax: +39 02 4 47 93 40

### **The Netherlands**

#### **Oldenzaal**

Tel: +31 (0)541 585000

Fax: +31 (0)541 585459

### **Norway**

#### **Ski**

Tel: +47 64 91 10 00

Fax: +47 64 91 10 90

### **Poland**

#### **Warsaw**

Tel: +48 (0)22 573 24 00

Fax: +48 (0)22 573 24 03

### **Portugal**

#### **Leca da Palmeira**

Tel: +351 22 9997 360

Fax: +351 22 9961 527

### **Slovakia**

#### **Ref. Czech Republic**

### **Spain**

#### **Madrid**

Tel: +34 91 675 73 00

Fax: +34 91 675 77 11

### **Sweden**

#### **Spånga**

Tel: +46 (0)8 597 950 00

Fax: +46 (0)8 597 951 10

### **United Kingdom**

#### **Warwick**

Tel: +44 (0)1926 317 878

Fax: +44 (0)1926 317 855

## International

### **Australia**

#### **Castle Hill**

Tel: +61 (0)2-9634 7777

Fax: +61 (0)2-9842 5111

### **Canada**

#### **Milton, Ontario**

Tel: +1 905-693-3000

Fax: +1 905-876-0788

### **China**

#### **Shanghai**

Tel: +86 21 5031 2525

Fax: +86 21 5834 3714

### **Asia Pacific Group**

#### **Hong Kong**

Tel: +852 2428 8008

Fax: +852 2425 6896

### **India**

#### **Mumbai**

Tel: +91 22 5613 7081/82-85

Fax: +91 22 2768 6841/6618

### **Japan**

#### **Tokyo**

Tel: +(81) 3 6408 3900

Fax: +(81) 3 5449 7201

### **Latin America Group**

#### **Brazil**

Tel: +55 51 3470 9144

Fax: +55 51 3470 9281

### **South Africa**

#### **Kempton Park**

Tel: +27 (0)11-961 0700

Fax: +27 (0)11-392 7213

### **USA**

#### **Cleveland (industrial)**

Tel: +1 216-896-3000

Fax: +1 216-896-4031

#### **Lincolnshire (mobile)**

Tel: +1 847-821-1500

Fax: +1 847-821-7600

**Parker Hannifin is the world's premier supplier of motion and control systems and solutions, with sales and manufacturing facilities throughout the world. For product information and details of your nearest Parker sales office, visit us at [www.parker.com](http://www.parker.com) or call free on 00800 2727 5374.**



Catalogue HY07-1110/UK  
06/06 PC

© Copyright 2006  
Parker Hannifin Corporation  
All rights reserved