

- Detects stoppage of a cylinder due to a pressure drop in the exhaust chamber
- For direct mounting to cylinders
- Choice of pneumatic, electrical or electronic output
- Wide range of sizes

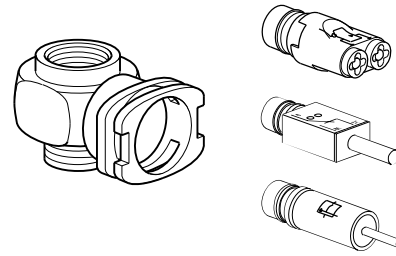

## Operating information

Operating pressure:	0 to 10 bar
Permissible fluids:	Air or neutral gas 50micron or filtration, lubricated or not
Operating temperature:	-15°C to +60°C
Storage temperature:	-40°C to +70°C
No. of operations with dry air at 6 bar 20°C 1 Hz:	10 million
Maximum operating frequency:	10 Hz
Output characteristics:	Pneumatic: Flow @ 6 bar 90l/m Electrical: C/contact 2,5A/250V AC, 5W 48V DC Electronic: PNP N/C or N/O 10 to 30V 75 mA DC
Maximum connecting torque:	M5 = 1Nm; 1/8 = 8Nm; 1/4 = 12Nm; 3/8 = 30Nm; 1/2 = 35Nm
Body material:	Thermo plastic
Connection thread:	Brass

**Dimensions and piloting pressures opposite page**

## Assembly

All back pressure sensors are a combination of two distinct parts: a banjo socket + a plug-in sensor.

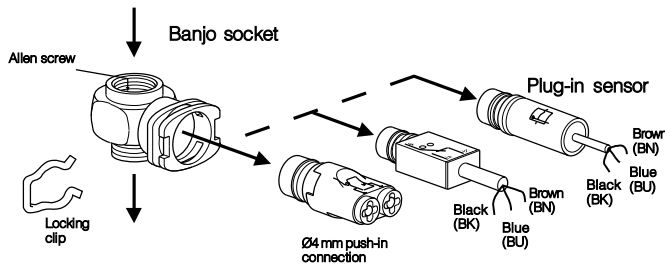

## Connection

Output signal connection

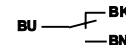

Pneumatic output sensor: Ø4 mm push-in

Electric output sensor

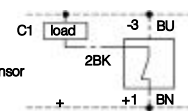

Solid state output sensor

## Banjo Sockets

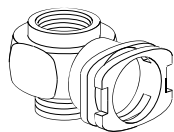

Thread Size for Cylinder Port	Female Thread	Tool Required	Weight Kg	Order code
M5	M5	8mm flat spanner	0,04	<b>PWS-B155</b>
G1/8	G1/8	5mm Allen key	0,04	<b>PWS-B188</b>
G1/4	G1/4	8mm Allen key	0,05	<b>PWS-B199</b>
G3/8	G3/8	10mm Allen key	0,07	<b>PWS-B133</b>
G1/2	G1/2	12mm Allen key	0,11	<b>PWS-B122</b>

## Plug-in Sensors

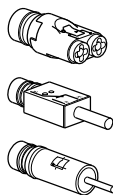

Sensing function	Output function	Output Connection	Output characteristics	Weight kg	Order code
Exhaust back pressure decay	Pneumatic	Push-in Ø4mm	NO valve flow rate at 6 bar 1,5 l/s	0,09	<b>PWS-P111</b>
	Electrical ~Ve = 3A	3 wires 0,5mm <sup>2</sup> length 2m	CO contact 12 to 230V ~ / 10VA* 12 to 48 VDC/5W*	0,08	<b>PWS-M1012</b>
	Solid state	3 wires 0,1mm <sup>2</sup> length 2m	PNP type NC 10/30VDC** 75 mA, NO	0,07	<b>PWS-E101</b> <b>PWS-E111</b>

\* Suitable for low currents : 250 V ~ / 4 mA ; 24 VDC / 10 mA \*\* Including ripple

- Detects stoppage of a cylinder due to a pressure drop in the exhaust chamber
- Single unit design
- For direct mounting to cylinders
- Pneumatic output
- Wide range of sizes

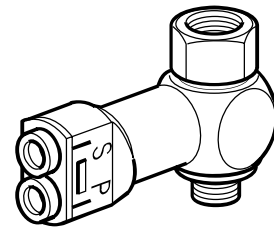

## Operating information

Operating pressure:	0 to 10 bar
Permissible fluids:	Air or neutral gas 50micron or filtration, lubricated or not
Operating temperature:	-15°C to +70°C
Storage temperature:	-20°C to +70°C
No. of operations with dry air at 6 bar 20°C 1 Hz:	10 million
Maximum operating frequency:	1 Hz
Output characteristics:	Flow @ 6 bar 90l/m
Maximum connecting torque:	M5 = 1Nm; 1/8 = 8Nm; 1/4 = 12Nm; 3/8 = 30Nm; 1/2 = 35Nm
Body material:	Zinc alloy / Thermo plastic
Connection thread:	Brass

## Back Pressure Sensor for Cylinder Mounting

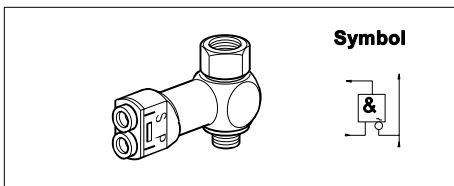

Thread Cylinder Port	Thread Supply Port	Bore Ømm	Weight Kg	Order code
M5	M5	2	0,10	<b>PWS-C5145</b>
G1/8	G1/8	5	0,11	<b>PWS-C5148</b>
G1/4	G1/4	7	0,10	<b>PWS-C5149</b>
G3/8	G3/8	10	0,17	<b>PWS-C5143</b>
G1/2	G1/2	14	0,15	<b>PWS-C5142</b>

## Back Pressure Sensors - Mono block - Dimensions

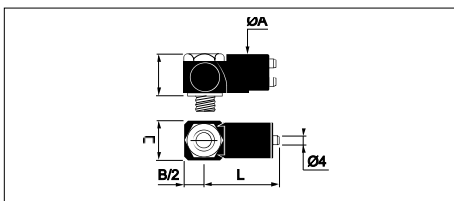

Order code	ØA	B	H	L
<b>PWS-CS145</b>	19	11,0	16,0	42
<b>PWS-CS148</b>	22	16,5	29,0	40
<b>PWS-CS149</b>	22	23,5	26,0	43
<b>PWS-CS143</b>	22	23,5	36,5	43
<b>PWS-CS142</b>	22	32,0	29,5	48

Plug-in & Monoblock back pressure sensors	Pilot	Depilot
	operating pressure	operating pressure
<b>PWS-P111</b>	6bar	6bar
<b>PWS-M1012</b>	4,4	0,4
<b>PWS-E101 &amp; E111</b>	1,0	0,6
<b>PWS-C</b>	0,7	0,5
	1,6 ±0,2	0,3

## Back Pressure Sensors - Modular - Dimensions

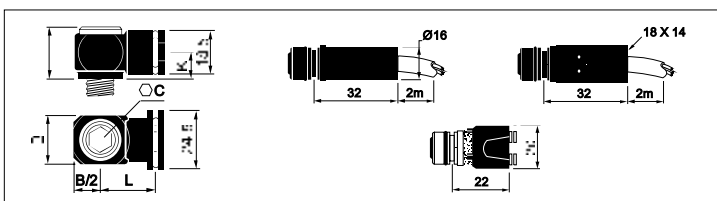

Order code	C	B	H	K	L
<b>PWS-B155</b>	8	11	16,5	10	17
<b>PWS-B188</b>	5	16	20,0	10	20
<b>PWS-B199</b>	8	21	20,0	10	22
<b>PWS-B133</b>	10	28	22,0	12	25
<b>PWS-B122</b>	12	33	26,0	14	26

- Adjusts the actuating force developed by a cylinder
- For direct mounting to power valve
- Threaded or push-in ports
- Adjustment by allen key or knurled knob
- Wide range of sizes

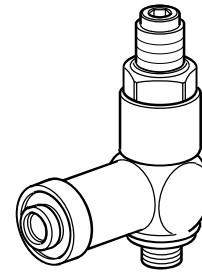

## Operating information

Operating pressure:	1 to 8 bar
Permissible fluids:	Air or neutral gas 50micron or filtration, lubricated or not
Flow:	See table below
Operating temperature:	-15°C to +70°C
Storage temperature:	-20°C to +70°C
Maximum connecting torque:	1/8 = 8Nm ; 1/4 = 12Nm; 3/8 = 30Nm
Body material:	Zinc alloy
Connection thread:	Brass
Adjustment mode:	Allen key

## With Push-in Connection

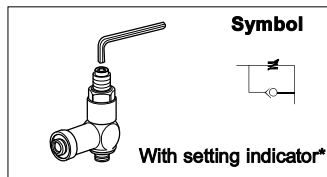

Thread size for cylinder port	Push-In Connection, Ømm	Qmax Input at 6 bar, l/min*	Weight kg	Order code
G1/8	6	570	0,30	<b>PWP-B1268</b>
G1/4	6	530	0,30	<b>PWP-B1269</b>
G1/4	8	870	0,30	<b>PWP-B1289</b>
G1/4	10	1400	0,54	<b>PWP-B1299</b>
G3/8	10	1530	0,55	<b>PWP-B1293</b>

\* Adjustment is carried out using a 6mm Allen key or a knurled knob.

## With Threaded Connection

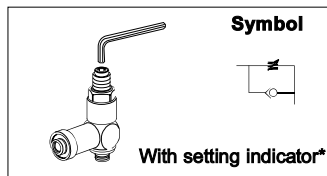

Thread size for cylinder port	Push-In Connection, Ømm	Qmax Input at 6 bar, l/min*	Weight kg	Order code
G1/8	G1/8	570	0,34	<b>PWP-B1888</b>
G1/4	G1/4	870	0,34	<b>PWP-B1899</b>
G3/8	G3/8	3200	0,62	<b>PWP-B1833</b>

\* Adjustment is carried out using a 6mm Allen key or a knurled knob.

## Clip-in knurled adjustment knob for optimisers

Weight kg	Order code
0,03	<b>PWP-Z13</b>

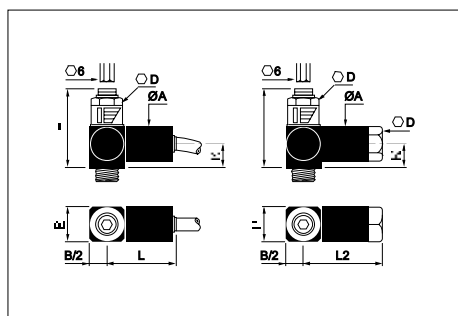

## Dimensions

Order code	ØA	B	D	H	K	L	L2
<b>PWP-B1268</b>	22	21	19	58,0	13,5	39	
<b>PWP-B1269</b>	22	21	19	58,0	13,5	39	
<b>PWP-B1289</b>	22	21	19	58,0	13,5	39	
<b>PWP-B1299</b>	27	28	19	65,5	16,5	50	
<b>PWP-B1293</b>	27	28	27	65,5	16,5	50	
<b>PWP-B1888</b>	22	21	19	58,0	13,5		43
<b>PWP-B1899</b>	22	21	19	58,0	13,5		43
<b>PWP-B1833</b>	27	28	27	65,5	16,5		55

- Enables a gradual increase in pressure
- For direct mounting to power valve
- Instant push-in connections
- Adjustment by allen key

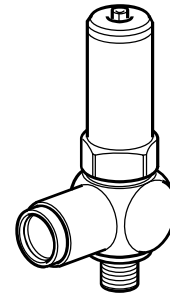

## Operating information

Operating pressure:	3 to 10 bar
Permissible fluids:	Air or neutral gas 50micron or filtration, lubricated or not
Flow:	See table below
Operating temperature:	-15°C to +70°C
Storage temperature:	-20°C to +70°C
No. of operations with dry air at 6 bar 20°C 1 Hz:	1/4 : 10 million; 3/8 : 5 million
Maximum operating frequency:	1 Hz
Maximum connecting torque:	1/4 = 12Nm; 3/8 = 30Nm
Body material:	Thermo plastic
Connection thread:	Brass
Adjustment mode:	Allen key

## With Push-in Connection

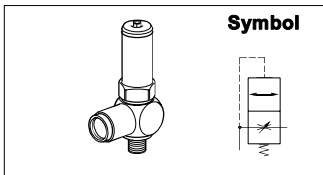

Thread	Push-in Connection, Ømm	Flow rate at 6 bar, l/min	Weight kg	Order code
G1/4	8	1500	0,07	<b>PWD-P2489</b>
G1/4	8	2000	0,12	<b>PWD-P2499</b>
G3/8	10	2000	0,13	<b>PWD-P2493</b>

## Dimensions

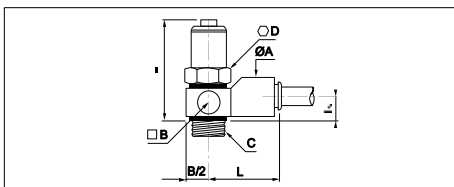

Order code	ØA	B	ØC	D	H maxi	K	L
<b>PWD-P2489</b>	15,0	20	G1/4	17	61	8,5	27,5
<b>PWD-P2499</b>	19,5	25	G1/4	22	62	11,8	41,0
<b>PWD-P2493</b>	19,5	25	G3/8	22	62	11,8	41,0

## Operation

A Soft starter provides a progressive increase in pressure, in a section of a pneumatic system. When pressure reaches half the supply pressure, full pressure is applied automatically.

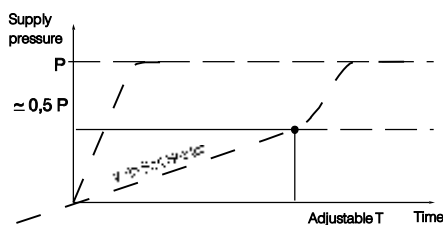

## Adjustment

Allen key adjustment of flow rate for slow pressure increase.

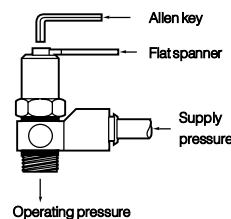

## Mounting

These compact devices with push-in tube connection are fitted to the N°1 port of the power valve.

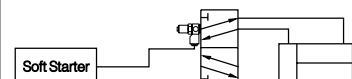

- Rugged brass body design
- Standard or high temperature options
- Low 0,1 bar operating pressure
- Full flow in one direction only
- Compact design



## Operating information

Operating pressure:	0,1 to 17 bar
Flow:	Qmax at 6 bar, l/min* 1/8 = 1200L/m; 1/4 - 1350 L/m
Operating temperature:	Standard: -26°C to +85°C High: -26°C to +230°C
Body material:	Brass
Seal material:	Standard: Nitrile High: Viton

## Standard version

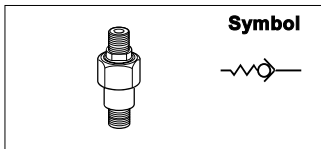

Thread size	Weight kg	Order code
G1/8	0,68	<b>3047X</b>
G1/4	0,72	<b>3047B</b>

## High temperature version

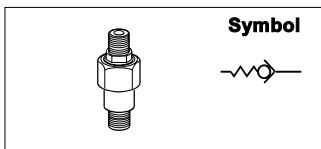

Thread size	Weight kg	Order code
G1/8	0,68	<b>3047XV</b>
G1/4	0,72	<b>3047BV</b>

## Dimensions

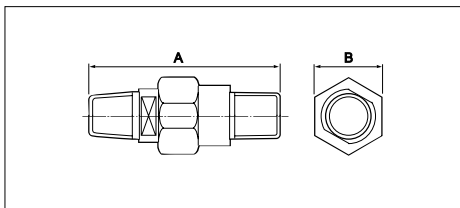

Order code	Port Size	A	B
<b>3047X/XV</b>	G1/8	51	21
<b>3047B/BV</b>	G1/4	49	21

- Aluminium bodies
- Long life
- Low opening pressure
- Full flow in one direction only

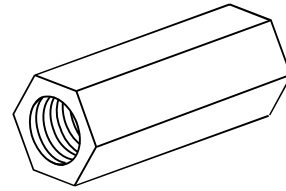

## Operating information

Operating pressure: 0,1 to 10 bar  
 Operating temperature: -20°C to +70°C  
 Body material: Anodised aluminium  
 Seal material: Nitrile

## VB - Aluminium

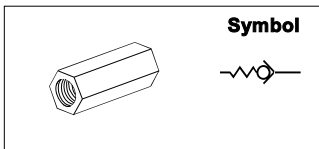

Port size	Weight kg	Order code
G1/8	0,01	<b>VB12-Q-NQ-5</b>
G1/4	0,01	<b>VB22-Q-NQ-5</b>
G1/2	0,05	<b>VB42-Q-NQ-5</b>

## Dimensions

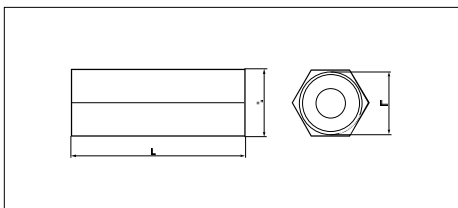

Order code	F	L	N
<b>VB12-Q-NQ-5</b>	G1/8	31	14
<b>VQB22-Q-NQ-5</b>	G1/4	40	17
<b>VB42-Q-NQ-5</b>	G1/2	59	27

- Low 0,1 bar operating pressure
- Full flow in one direction only
- Compact design
- Instant push-in connections

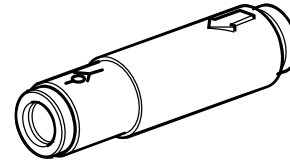

## Operating information

Operating pressure: 0,2 to 10 bar  
 Flow: See below  
 Operating temperature: -15°C to +70°C  
 Storage temperature: -20°C to +70°C  
 Body material: Thermo plastic

## Line Mounted Non-return Valves

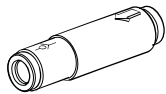

Symbol



Sold in lots of 10

Push-in Connection Ømm	Flow Rate at 6 bar, l/s	Weight	Order code Kg
4	200	0,01	<b>PWA-L1444</b>
6	660	0,02	<b>PWA-L1446</b>
8	1600	0,02	<b>PWA-L1448</b>

## Dimensions

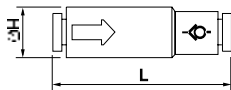

Order code	ØH	L
<b>PWA-L1444</b>	11,0	43,0
<b>PWA-L1466</b>	13,0	49,5
<b>PWA-L1488</b>	13,5	55,0

- For the remote mounting of cylinder control accessories
- Suitable for use with
  - Flow regulators
  - Blockers
  - Unloaders
  - Combined devices
  - Optimisers
  - Soft start

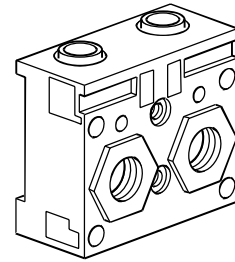

## Operating information

Operating pressure:	0,2 to 10 bar
Flow:	See below
Operating temperature:	-15°C to +70°C
Storage temperature	-20°C to +70°C
Body material:	Thermo plastic

## Terminal Block Subbases for Cylinder Controls\*

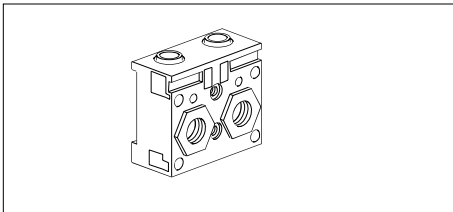

For Mounting Other Cylinder Controls	Push-In Connection	Ømm	Bore Ømm	Weight Kg	Order code
G1/8	6	4	0,05	<b>PZC-B2268</b>	
G1/4	8	6	0,05	<b>PZC-B2289</b>	

\* For remote mounting of all cylinder controls, when mounting on power valves or cylinders is impractical.  
The subbase is designed for mounting two components side by side.

## Dimensions

