

- Very fast response times
- Accurate output pressure
- Micro parameter settings
- Selectable I/O parameters
- Quick, full flow exhaust
- LED display indicates output pressure
- No air consumption in steady state
- Multiple mounting options
- Protection to IP65
- P31P flows to 19 dm³/s (40 scfm)
- P32P flows to 57 dm³/s (120 scfm)



P31PA Series
Bottom exhaust



P32PA Series
Bottom exhaust

Order Key

P 3	PA	2	2	1 A	
Port size Global Mini (1/4") 1 Global Compact (1/2") 2		Pressure Range 0 - 2 bar Z 0 - 7 bar S 0 - 10 bar D		Output Signal Digital, PNP 1) D PNP or 0-10V 2) P NPN or 0-10V 3) N 4-20mA fixed 4) M	
Thread type BSPP 1 NPT 9		Power supply 24 volts 2		Input connector M12 (4 pin) 1	
Port size Global Mini (1/4") 2 Global Compact (1/2") 4		Control Signal 0-10 V V 4-20 mA A			
Version Bottom ported exhaust NC A Bottom ported forced exhaust (NO) * E		* When the supply voltage is lost the unit will automatically exhaust the regulated pressure to 0 bar (atmospheric pressure) 1) Digital PNP output only, no analogue output selectable 2) Digital PNP and analogue 0-10V outputs selectable, by means of parameter 6. (Factory default 0-10V) 3) Digital NPN and analogue 0-10 V outputs selectable by means of parameter 6. (Factory default 0-10V) 4) Analogue 4-20mA output only. Note: On all analogue outputs the F.S. value can be adjusted by means of parameter 8			

P31P Mounting brackets

Order Code	Description
P3HKA00ML	L-Bracket mounting kit
P3HKA00MC	Foot bracket mounting kit

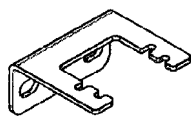

L-Bracket

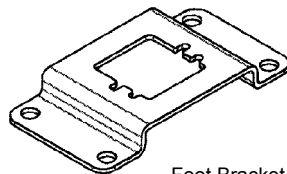

Foot Bracket

P32P Mounting brackets

Order Code	Description
P3KKA00ML	L-Bracket mounting kit
P3KKA00MC	Foot bracket mounting kit

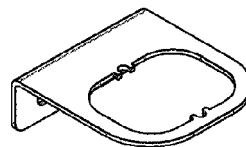

L-Bracket

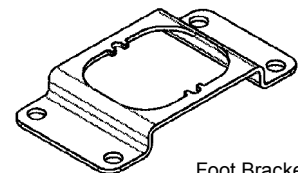

Foot Bracket

Cables

Order Code	Description
P8L-MC04A2A-M12	2 mtr. cable with moulded straight M12x1 connector
P8L-MC04R2A-M12	2 mtr. cable with moulded 90 degree M12x1 connector.

Note:

These brackets fit both Proportional Regulators and Combined Soft Start & Dump Valves.
Dimensions see page: 61

Technical information

Pneumatics

Working medium

Compressed air or inert gasses, filtered to min. 40µ, lubricated or non-lubricated, dried or un-dried, pressure dewpoint 3-5°C.

Supply pressure

Max. Operating Pressure:
 2 bar unit: 3 bar (43.5 PSI)
 7 bar unit: 10.5 bar (152 PSI)
 10 bar unit: 10.5 bar (152 PSI)
 Min. Operating Pressure P2 Pressure + 0,5 bar (7.3 PSI)

Pressure control range

Available in three pressure ranges, 0-2 bar, 0-7 bar or 0-10 bar. Pressure range can be changed through the software at all times. (parameter 19)

Temperature range

0°C up to +50°C (32°F up to 122°F)

Weights:

P31P = 0.291 kg (0.64 lbs)
 P32P = 0.645 kg (1.42 lbs)

Air consumption

No consumption in stable regulated situation.

Display

The regulator is provided with a digital display, indicating the output pressure, either in BAR or PSI. The factory setting is as indicated on the label, can be changed through to software at all times (parameter 14).

Electronics

Supply voltage

24 VDC +/- 10%

Power consumption

Max. 1.1W with unloaded signal outputs

Control signals

The electronic pressure regulator can be externally controlled through an analogue control signal of either 0-10V or 4-20mA.(parameter 4).

Output signals

As soon as the output pressure is within the signal band a signal is given of 24V DC, PNP Ri = 1 kOhm Outside the signal band this connection is 0V.

Connections

(In case of output signal (option D))

Central M12 connector 4-pole

ISO 20401
 4-Pin Micro
 (Top cover)

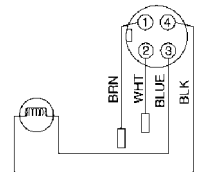

The electrical connections are as follows:

Pin no.	Function	Colour
1	24V supply	Brown
2	0 to 10 V control signal Ri = 100 kOhm	White
2	4 to 20mA control signal Ri = 500 kOhm	White
3	0V (GND) supply	Blue
4	24V alarm output signal	Black

* In case of 4-20 mA the Ri will be 500 Ohm.

Schematic

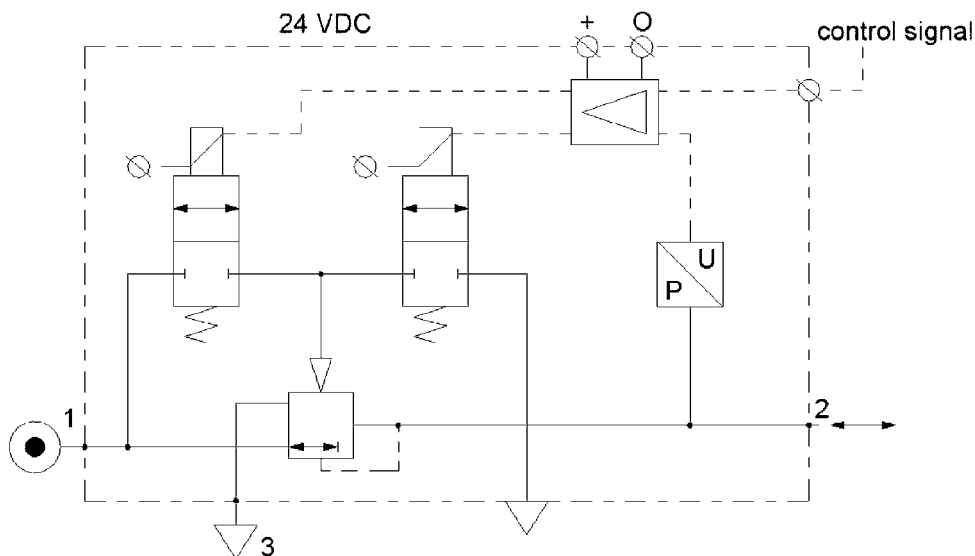

Technical information

Dead band : The dead band is preset at 1,3% F.S. (parameter 13)

Accuracy : Linearity: = < 0,3% F.S.

Proportional band : The proportional band is preset at 10% F.S.

Fail safe operation :

After interrupting the **power supply** the present output pressure is maintained at approximately the same level.

After switching on the power supply again the pressure can be adjusted immediately by giving a new control signal.

Full exhaust : Complete exhaust of the regulator is defined as $P2 \leq 1\% \text{ F.S.}$

Degree of protection: IP 65

Full scale (F.S.)

For 2 bar versions this will 2 bar, for the 7 and 10 bar version full scale will be 10 bar.

EU conformity : CE: standard

EMC: according to directive 89/336/EEC

The new pressure regulator is in accordance with:

- EN 61000-6-1:2001**
- EN 61000-6-2:2001**
- EN 61000-6-3:2001**
- EN 61000-6-4:2001**

These standards ensure that this unit meets the highest level of EMC protection.

Mounting position : Preferably vertically, with the cable gland on top.

Materials: P31P & P32P

- Magnet Core Steel
- Solenoid Valve Poppet FPM
- Solenoid Valve Housing Techno Polymer
- Regulator Body (P31P & P32P versions) Aluminium
- Regulator Top Housing Nylon
- Valve Head Brass & NBR
- Remaining Seals NBR

Advanced functionality

Pilot valve protection

When the required output pressure can not be achieved because of a lack of input pressure the unit will open fully and will display NoP. Approximately every 10 seconds the unit will retry. The output pressure will then be approximately equal to the inlet pressure. As soon as the input pressure is back on the required level, the normal control function follows.

Safety exhaust

Should the **control signal** fall below 0,1 volts the valve will automatically dump downstream system pressure .

Fail safe

When the **supply voltage** drops, the electronic control reverts to the fail safe mode. The last known output pressure is maintained at approximately the same level depending upon air consumption. The digital display indicates the last known pressure setting. When the supply voltage is reinstated to the correct level, the valve moves from the fail safe mode and the output pressure immediately follows the control signal requirement. The display indicates the actual output pressure.

Input protection

The unit has built-in protection against failure and burnout resulting from incorrect input value, typically:

The 24v DC supply is incorrectly connected to the setpoint input, the display will show 'OL', as an overload indication. The unit will need to be rewired and when correctly connected will operate normally.

The overload indicator 'OL' will also appear should the wrong input value be applied or the wrong input value be programmed: 4 - 20m instead of 0 - 10V. To correct this a different set point value should be input or the unit reprogrammed to correct the set point value acceptance. (via parameter 4).

Response time	P31P	P32P
2 to 4 bar	25 msecs	35 msecs
1 to 6 bar	55 msecs	135 msecs
4 to 2 bar	70 msecs	85 msecs
6 to 1 bar	80 msecs	225 msecs

To fill volume of:
 100cm³ - P31P
 330cm³ - P32P
 connected to the outlet of the regulator.

Flow Charts

P31P Regulator 1/4" Ports

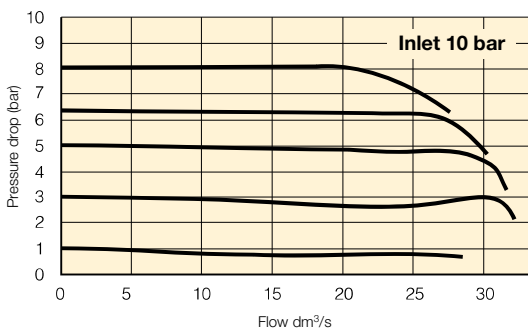

P32P Regulator 1/2" Ports

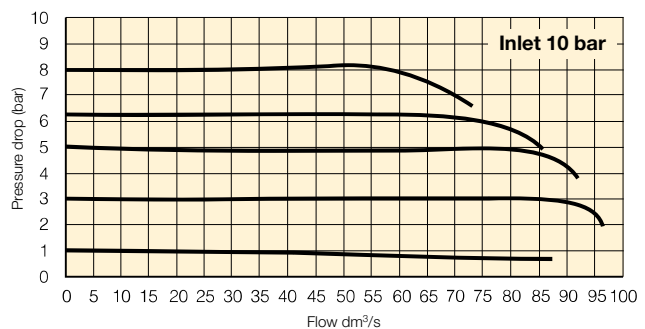

How to change parameters

Pressing the Accept key “acc” for more than 3 seconds, will activate parameter change mode. The user can then select the parameters by pressing up or down key. (display will show Pxx). When parameter number is correct, pressing accept again will enter parameter number.(display will show parameter value).

Pressing the up or down key will change the parameter itself. (display will flash indicating parameter editing mode). Pressing the accept key will accept the new parameter value. (all digits will flash whilst being accepted).

After releasing all keys , the next parameter number will be presented on the display. (you may step to the next parameter). When no key is pressed, after 3 seconds the display will show the actual output pressure.

When the unit is initially powered up allow approximately 10 seconds for the unit to “boot-up” before changing parameter settings.

Only parameter numbers 0, 4, 6, 8, 9, 14, 18, 19, 20, 12, 13 and 21 are accessible to edit. All other parameters are fixed.

Manual mode









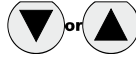

When keys DOWN and UP are pressed during startup, (connecting to the 24V power supply) manual mode is activated. This means that the user is able to in/decrease the output pressure of the regulator, by pressing the UP or DOWN key. During this action the display will blink, indicating that the manual mode is activated. After powering up again, the unit will revert back to normal mode.

Back to Factory Setting

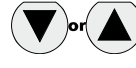
After start up. (Power is on)

Entering this value in parameter 0 will store the calibrated factory data into the working parameters. (Default calibration data is used)

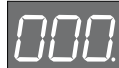
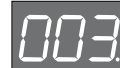
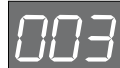









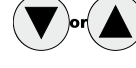

Parameter Number 0 – Reset Back to Factory Settings

Step	1	2	3	4	5	
Press 	 3-6 seconds					
Until Display Reads			 Flashing Decimal	 Flashing Decimal	 Flashing	
Description	Accesses changeable parameters	Accesses parameter no. 0	Displays current parameter value.	Edits parameter. 3 = standard factory settings. If other than 3, use Up or Down Arrow and accept 3	Accepts and saves new parameter setting.	Sequences to next parameter.











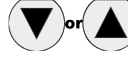

Set Control Signal

The unit is factory set for 0-10 V control signal. If 4-20 mA control signal is required, change parameter 4.











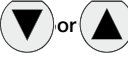

Parameter Number 4 – Set Control Signal in Volts or Milliamps

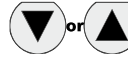
Step	1	2	3	4	5	
Press 	 3-6 seconds					
Until Display Reads			 Flashing Decimal	 Flashing Decimal	 Flashing	
Description	Accesses changeable parameters	Accesses parameter no. 4	Displays current parameter value. 1 = V 0 = mA	Edits parameter	Accepts and saves new parameter setting.	Sequences to next parameter.

Parameter Number 6 – Set output signal

Step	1	2	3	4	5	
Press 	 3-6 seconds					
Until Display Reads			 Flashing Decimal	 Flashing Decimal (value 0, 1 or 2)	 Flashing	
Description	Accesses changeable parameters	Accesses parameter no. 06	Displays current parameter value. 1 =m factory default for P3H with analog options	Edits parameter 0 = digital (NPN or PNP) 1 = analog 0 .. 10 V 2 = analog 4...20 mA	Accepts and saves new parameter setting.	Sequences to next parameter.











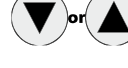

Parameter Number 8 – Adjust span analog output signal

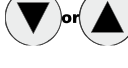
Step	1	2	3	4	5	
Press 	 3-6 seconds					
Until Display Reads			 Flashing Decimal (for 2 bar versions value = 92)	 Flashing Decimal (value between 0 and 130)	 Flashing	
Description	Accesses changeable parameters	Accesses parameter no. 8	Displays current parameter value.	Edits parameter	Accepts and saves new parameter setting and implements the new analog signal span	Sequences to next parameter.

Adjust Digital Display

If necessary, adjustments can be made to the digital display readout in order to match to an external pressure gauge.











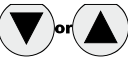

Parameter Number 9 – Adjust Displayed Pressure

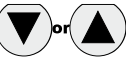
Step	1	2	3	4	5	
Press 	 3-6 seconds					
Until Display Reads			 Flashing Decimal	 Flashing Decimal	 Flashing	
Description	Accesses changeable parameters	Accesses parameter no. 9	Displays current digital display.	Use up or down arrows and accept, to match the readout to an external pressure gauge.	Accepts and saves new parameter setting.	Sequences to next parameter.

Set Pressure Scale

Units with NPT port threads are supplied with a factory set PSI pressure scale. Use parameter 14 to change scale to bar.











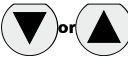

Parameter Number 14 – Set Pressure Scale in PSI or bar

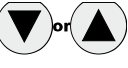
Step	1	2	3	4	5	
Press 	 3-6 seconds					
Until Display Reads			 Flashing Decimal	 Flashing Decimal	 Flashing	
Description	Accesses changeable parameters	Accesses parameter no. 14	Display current parameter value. 1 = PSI 0 = bar 2 = Mpa	Edits parameter	Accepts and saves new parameter setting.	Sequences to next parameter.

Preset Minimum Pressure

If there is a need for a pre-set minimum pressure, use parameter 18. (Note: preset pressure is affected by % P19.)

Parameter Number 18 – Set Minimum Preset Pressure

Step	1	2	3	4	5	
Press 	 3-6 seconds					
Until Display Reads			 Flashing Decimal	 Flashing Decimal (value between 0 and 200)	 Flashing	
Description	Accesses changeable parameters	Accesses parameter no. 18	Displays current parameter value. Incremental value is: <u>2 bar unit:</u> x 2 mbar x % P19 <u>10 bar unit:</u> x 10 mbar x % P19	Edits parameter	Accepts and saves new parameter setting.	Sequences to next parameter.

Set Pressure Correction









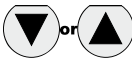

Pressure correction allows the user to set a maximum pressure as a percentage of secondary pressure F.S.

Example: If F.S. is 10 bar, set parameter 19 to 50 for maximum preset pressure of 5 bar.

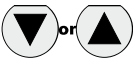
Pressure correction also affects the minimum preset pressure in parameter 18.

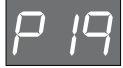
Example: If F.S. is 10 bar and parameter 18 is set to a value of 100 (1 bar), and parameter 19 is set to 50%, then the actual minimum preset pressure seen is 0.5 bar.

Parameter Number 19 – Set Maximum Preset Pressure











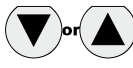

Step	1	2	3	4	5	
Press 	 3-6 seconds					
Until Display Reads			 Flashing Decimal	 Flashing Decimal (value between 0 and 100)	 Flashing	
Description	Accesses changeable parameters	Accesses parameter no. 19	Displays current parameter value. Incremental value is % of F.S.	Edits parameter	Accepts and saves new parameter setting.	Sequences to next parameter.

Behavior Control

The regulation speed of the pressure regulator can be modified by means of one parameter. (P 20)

The value in this parameter has a range from 0-5. A higher value indicates slower regulation speed, but will be more stable.

Parameter Number 20 – Set Behavior Control

Step	1	2	3	4	5	
Press 	 3-6 seconds					
Until Display Reads			 Flashing Decimal	 Flashing Decimal (value between 0 and 5)	 Flashing	
Description	Accesses changeable parameters	Accesses parameter no. 20	Displays current parameter value.	Edits parameter 0 = custom set* 1 = fastest (narrow proportional band) 2 = fast 3 = normal 4 = slow 5 = slowest (proportional band is broad)	Accepts and saves new parameter setting.	Sequences to next parameter.













*When the value 0 is entered, you are able to create your own custom settings true parameters 12, 13 and 21.

Fine Settings

Set Proportional Band

Proportional band is used for setting the reaction sensitivity of the regulator. The displayed value is X 10 mbar and has a range between 50 (0.5 bar) and 250 (2.5 bar).











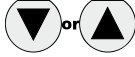

Parameter Number 12 – Set Proportional Band (P20 Must be Set to 0)

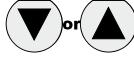
Step	1	2	3	4	5	
Press 	 3-6 seconds					
Until Display Reads			 Flashing Decimal	 Flashing Decimal (value between 50 and 250)	 Flashing	
Description	Accesses changeable parameters	Accesses parameter no. 12	Displays current parameter value. Incremental value is X 10 mbar.	Edits parameter	Accepts and saves new parameter setting.	Sequences to next parameter.

Set Deadband











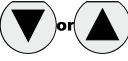

Deadband is the minimum limit of accuracy at which the regulator is set for normal operation. The displayed value is X 10 mbar and has a range between 2 (20 mbar) and 40 (400 mbar).

Parameter Number 13 – Set Deadband (P20 Must be Set to 0)







Step	1	2	3	4	5	
Press 	 3-6 seconds					
Until Display Reads			 Flashing Decimal	 Flashing Decimal (value between 4 and 40)	 Flashing	
Description	Accesses changeable parameters	Accesses parameter no. 13	Displays current parameter value. Incremental value is X 10 mbar.	Edits parameter	Accepts and saves new parameter setting.	Sequences to next parameter.

Proportional Effect

Parameter Number 21 – Set Proportional Effect (P20 Must be Set to 0)

Step	1	2	3	4	5	
Press 	 3-6 seconds					
Until Display Reads			 Flashing Decimal	 Flashing Decimal (value between 5 and 100)	 Flashing	
Description	Accesses changeable parameters	Accesses parameter no. 21	Displays current parameter value.	Edits parameter 5 = fastest regulation 100 = slowest regulation	Accepts and saves new parameter setting.	Sequences to next parameter.

Parameter Number 39 – Displays Current Software Version

Step	1	2	3	
Press 	 3-6 seconds			
Until Display Reads			 Flashing Decimal	
Description	Accesses parameters	Accesses parameter no. 39	Displays current parameter value. XXX = current software version	

P31P

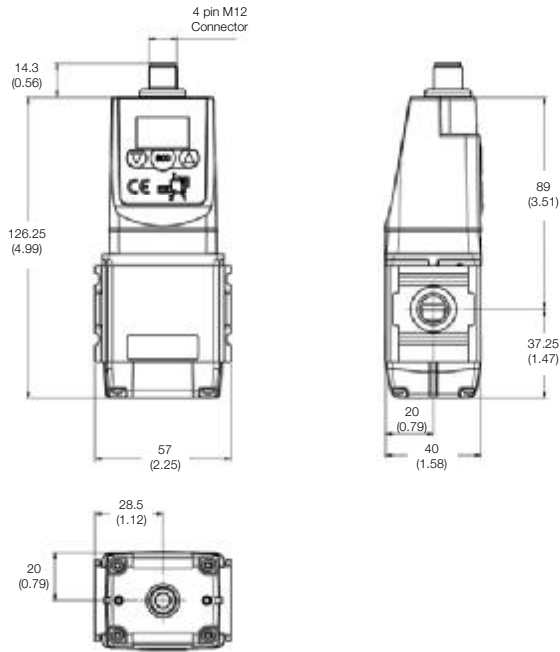

L-Bracket

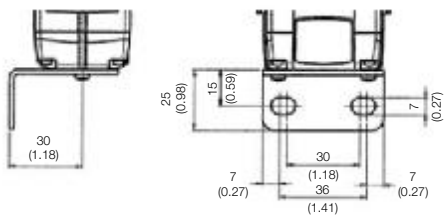

Foot Bracket

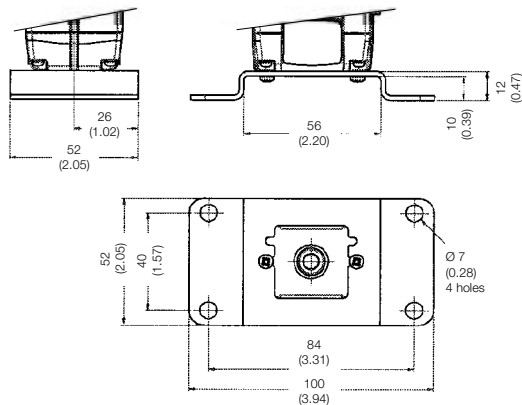

P32P

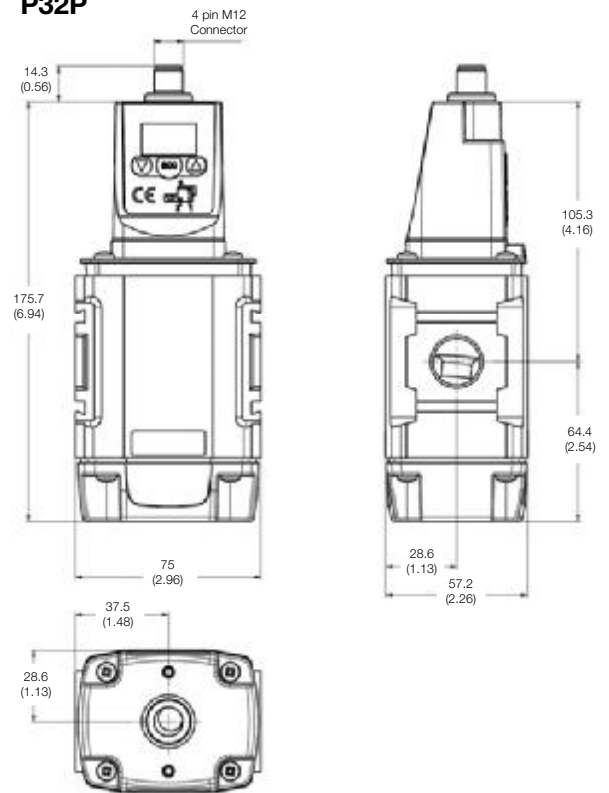

L-Bracket

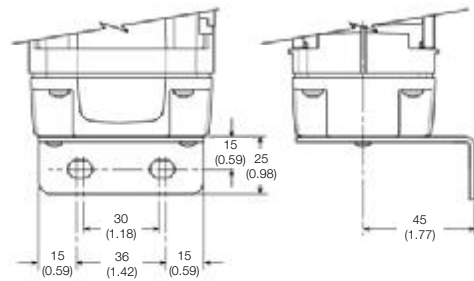

Foot Bracket

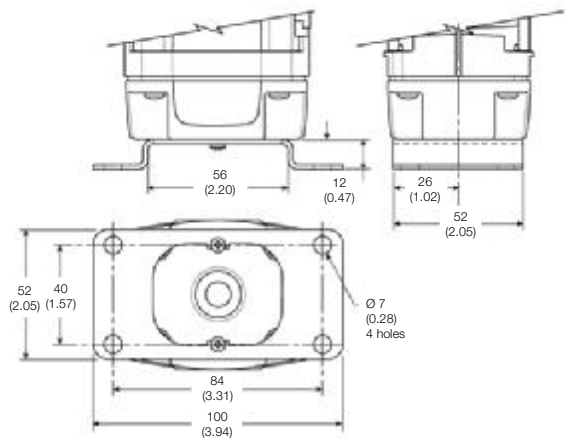

Dimensions are in mm (Inches)